

# Panasonic®

## LCD Projector

# Operating Instructions

Model No. **PT-AX100U**

ENGLISH

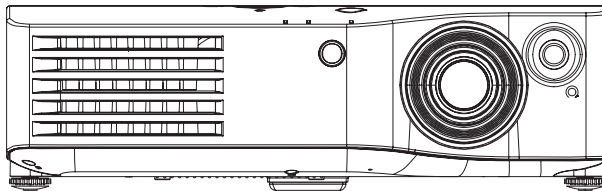

**HDMI™**  
HIGH-DEFINITION MULTIMEDIA INTERFACE

For assistance, please call: 1 - 888 - View - PTV (843 - 9788)  
or send e - mail to: [consumerproducts@panasonic.com](mailto:consumerproducts@panasonic.com)  
or visit us at [www.panasonic.com](http://www.panasonic.com)

(U.S.A)

For assistance, please call: 787 - 750 - 4300  
or visit us at <http://panasonic.net>

(Puerto Rico)

Before operating this product, please read these instructions carefully and save this manual for future use.

# Important Safety Notice

## Dear Panasonic Customer:

This instruction booklet provides all the necessary operating information that you might require. We hope it will help you to get the most out of your new product, and that you will be pleased with your Panasonic LCD projector. The serial number of your product may be found on its bottom. You should note it in the space provided below and retain this booklet in case service is required.

Model number: **PT-AX100U**

Serial number:

**WARNING:** TO REDUCE THE RISK OF FIRE OR ELECTRIC SHOCK, DONOT EXPOSE THIS PRODUCT TO RAIN OR MOISTURE.

**Power Supply:** This LCD Projector is designed to operate on 100 V - 240 V, 50 Hz/ 60 Hz AC, house current only.

**CAUTION:** The AC power cord which is supplied with the projector as an accessory can only be used for power supplies up to 125 V, 7 A. If you need to use higher voltages or currents than this, you will need to obtain a separate 250 V power cord. If you use the accessory cord in such situations, fire may result.

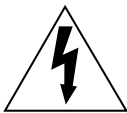

The lightning flash with arrowhead symbol, within an equilateral triangle, is intended to alert the user to the presence of uninsulated "dangerous voltage" within the product's enclosure that may be of sufficient magnitude to constitute a risk of electric shock to persons.



The exclamation point within an equilateral triangle is intended to alert the user to the presence of important operating and maintenance (servicing) instructions in the literature accompanying the product.

**CAUTION:** This equipment is equipped with a three-pin grounding-type power plug. Do not remove the grounding pin on the power plug. This plug will only fit a grounding-type power outlet. This is a safety feature. If you are unable to insert the plug into the outlet, contact an electrician. Do not defeat the purpose of the grounding plug.

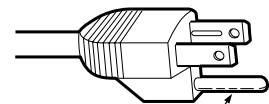

Do not remove

## Important Safety Notice

### **WARNING:**

This equipment has been tested and found to comply with the limits for a Class B digital device, pursuant to Part 15 of the FCC Rules. These limits are designed to provide reasonable protection against harmful interference in a residential installation. This equipment generates, uses and can radiate radio frequency energy and, if not installed and used in accordance with the instructions, may cause harmful interference to radio communications. However, there is no guarantee that interference will not occur in a particular installation. If this equipment does cause harmful interference to radio or television reception, which can be determined by turning the equipment off and on, the user is encouraged to try to correct the interference by one or more of the following measures:

- Reorient or relocate the receiving antenna.
- Increase the separation between the equipment and receiver.
- Connect the equipment into an outlet on a circuit different from that to which the receiver is connected.
- Consult the dealer or an experienced radio/TV technician for help.

**FCC CAUTION:** To assure continued compliance, use only shielded interface cables when connecting to computers or peripheral devices. Any unauthorized changes or modifications to this equipment will void the users authority to operate.

If you use serial port to connect PC for external control of projector, you must use optional RS-232C serial interface cable with ferrite core. Any unauthorized changes or modifications to this equipment will void the user's authority to operate.

Indication based on the German law "Geräte- und Produktsicherheitsgesetz"

**Directive 2001/95/EC (Article 5);**

**Panasonic Marketing Europe GmbH**

**Hagenauer Str. 43 65203 Wiesbaden F.R.GERMANY**

**WARNING:** Not for use in a computer room as defined in the Standard for the Protection of Electronic Computer/Data Processing Equipment, ANSI/NFPA 75.

### **Declaration of Conformity**

Model Number: PT-AX100U

Trade Name: **Panasonic**

Responsible party: Panasonic North America

Address: One Panasonic Way 4B - 9 Secaucus, New Jersey 07094

Telephone number: 1 - 888 - View - PTV (843 - 9788)

This device complies with Part 15 of the FCC Rules, Operation is subject to the following two conditions: (1) This device may not cause harmful interference, and (2) this device must accept any interference received, including interference that may cause undesired operation.

# Contents

## ■ Quick Steps

### 1. Set up your projector

See “Setting up” on page 14.



### 2. Connect with other devices

See “Connections” on page 18.



### 3. Prepare the Remote control

See “Remote control” on page 11.



### 4. Start projecting

See “Switching the projector on/off” on page 19.



### 5. Adjust the image

See “Menu Navigation” on page 26.

## Important Safety Notice..... 2

## Preparation

### Precautions with regard to safety ..... 6

WARNINGS ..... 6

CAUTIONS..... 8

### Before use..... 9

Accessories ..... 9

Cautions when transporting ..... 9

Cautions when installing ..... 9

Cautions on use ..... 10

### About Your Projector ..... 11

Remote control..... 11

Projector ..... 12

## Getting Started

### Setting up..... 14

Screen size and throw distance ..... 14

Projection method ..... 15

Front leg adjuster and throwing angle ..... 15

Lens shift and positioning..... 16

### Connections ..... 18

Before connection to the projector ..... 18

Connecting with AV devices..... 18

Connecting with HDMI/PC ..... 18

## Basic Operation

### Switching the projector on/off ..... 19

Power cord ..... 19

POWER indicator ..... 19

Switching on the projector ..... 20

Switching off the projector ..... 20

### Projecting an image ..... 21

Selecting the input signal ..... 21

Positioning the image..... 21

### Remote control operation ..... 22

Operating range ..... 22

Input switching ..... 22

Capturing an image..... 22

Switching the aspect ratio ..... 23

Switching off the projector automatically ..... 23

Resetting to the factory default settings ..... 23

Turning on the button backlight..... 23

Switching the picture mode ..... 23

Adjusting the image..... 24

Setting your own color profile..... 24

## Settings

<b>Menu Navigation</b> .....	<b>26</b>
Navigating through the MENU .....	26
Main menu .....	26
Sub-menu.....	27
<b>PICTURE Menu</b> .....	<b>28</b>
PICTURE MODE.....	28
CONTRAST .....	28
BRIGHTNESS.....	28
COLOR .....	28
TINT .....	29
SHARPNESS .....	29
COLOR TEMPERATURE .....	29
DYNAMIC IRIS.....	29
LIGHT HARMONIZER .....	29
ADVANCED MENU.....	29
FAVOURITE SAVE.....	30
FAVOURITE LOAD.....	30
SIGNAL MODE .....	30
<b>POSITION Menu</b> .....	<b>31</b>
H - POSITION .....	31
V - POSITION .....	31
DOT CLOCK .....	31
CLOCK PHASE.....	31
ASPECT.....	32
WSS.....	33
OVER SCAN .....	33
KEYSTONE.....	33
AUTO SETUP .....	33
<b>OPTION Menu</b> .....	<b>34</b>
INPUT GUIDE .....	34
OSD DESIGN.....	34
OSD POSITION .....	34
BACK COLOR.....	34
STARTUP LOGO .....	34
AUTO SEARCH .....	34
HDMI SIGNAL LEVEL.....	34
INSTALLATION.....	35
SLEEP .....	35
ALTITUDE.....	35
LAMP POWER.....	35
LAMP RUNTIME .....	35
TEST PATTERN .....	35

## Maintenance

<b>TEMP and LAMP Indicators</b> .....	<b>36</b>
Controlling alerts .....	36
<b>Care and Replacement</b> .....	<b>37</b>
Before cleaning .....	37
Cleaning your projector .....	37
Before replacing the Lamp unit .....	38
When to replace the Lamp unit .....	38
Replacing the lamp unit.....	39
<b>Troubleshooting</b> .....	<b>40</b>
<b>Appendix</b>	
<b>Technical Information</b> .....	<b>41</b>
List of compatible signals .....	41
Serial terminal .....	42
Menu structure .....	45
<b>Specifications</b> .....	<b>46</b>
<b>Dimensions</b> .....	<b>48</b>
<b>Trademark acknowledgements</b> .....	<b>49</b>
<b>Index</b> .....	<b>50</b>

# Precautions with regard to safety

## WARNINGS

**If you notice smoke, strange smells or noise coming from the projector, disconnect the power cord plug from the wall outlet.**

- Do not continue to use the projector in such cases, otherwise fire or electric shocks could result.
- Check that no more smoke is coming out, and then contact an Authorized Service Center for repairs.
- Do not attempt to repair the projector yourself, as this can be dangerous.

**Do not install this projector in a place which is not strong enough to take the full weight of the projector.**

- If the installation location is not strong enough, it may fall down or tip over, and severe injury or damage could result.

**Installation work (such as ceiling suspension) should only be carried out by a qualified technician.**

- If installation is not carried out correctly, there is the danger that injury or electric shocks may occur.
- Do not use other than an authorized ceiling mount bracket.

**If foreign objects or water get inside the projector, or if the projector is dropped or the cabinet is broken, disconnect the power cord plug from the wall outlet.**

- Continued use of the projector in this condition may result in fire or electric shocks.
- Contact an Authorized Service Center for repairs.

**Do not overload the wall outlet.**

- If the power supply is overloaded (for example, by using too many adapters), overheating may occur and fire may result.

**Do not remove the cover or modify it in any way.**

- High voltages can cause fire or electric shocks.
- For any inspection, adjustment and repair work, please contact an Authorized Service Center.

**Clean the power cord plug regularly to prevent it from becoming covered in dust.**

- If dust builds up on the power cord plug, the resulting humidity can damage the insulation, which could result in fire. Pull the power cord plug out from the wall outlet and wipe it with a dry cloth.
- If not using the projector for an extended period of time, pull the power cord plug out from the wall outlet.

**Do not do anything that might damage the power cord or the power cord plug.**

- Do not damage the power cord, make any modifications to it, place it near any hot objects, bend it excessively, twist it, pull it, place heavy objects on top of it or wrap it into a bundle.
- If the power cord is used while damaged, electric shocks, short-circuits or fire may result.
- Ask an Authorized Service Center to carry out any repairs to the power cord that might be necessary.

**Do not handle the power cord plug with wet hands.**

- Failure to observe this may result in electric shocks.

**Insert the power cord plug securely into the wall outlet.**

- If the plug is not inserted correctly, electric shocks or overheating could result.
- Do not use plugs which are damaged or wall outlets which are coming loose from the wall.

**Do not place the projector on top of surfaces which are unstable.**

- If the projector is placed on top of a surface which is sloped or unstable, it may fall down or tip over, and injury or damage could result.

**Do not place the projector into water or let it become wet.**

- Failure to observe this may result in fire or electric shocks.

**Do not place the projector on soft materials such as carpets or sponge mats.**

- Doing so may cause the projector to overheat, which can cause burns, fire or damage to the projector.

**Do not place liquid containers on top of the projector.**

- If water spills onto the projector or gets inside it, fire or electric shocks could result.
- If any water gets inside the projector, contact an Authorized Service Center.

**Do not insert any foreign objects into the projector.**

- Do not insert any metal objects or flammable objects into the projector or drop them onto the projector, as doing so can result in fire or electric shocks.

**Do not allow the + and - terminals of the batteries to come into contact with metallic objects such as necklaces or hairpins.**

- Failure to observe this may cause the batteries to leak, overheat, explode or catch fire.
- Store the batteries in a plastic bag and keep them away from metallic objects.

**During a thunderstorm, do not touch the projector or the cable.**

- Electric shocks can result.

**Do not use the projector in a bath or shower.**

- Fire or electric shocks can result.

**Do not place your skin into the light beam while the projector is being used.**

- Strong light is emitted from the projector's lens. If you place directly into this light, it can hurt or damage your skin.

**Do not look into the lens while the projector is being used.**

- Strong light is emitted from the projector's lens. If you look directly into this light, it can hurt and damage your eyes.
- Be especially careful not to let young children look into the lens. In addition, turn off the power and disconnect the power cord plug when you are away from the projector.

**Do not place your hands or other objects close to the air outlet port.**

- Heated air comes out of the air outlet port. Do not place your hands or face, or objects which cannot withstand heat close to this port [allow at least 10 cm (4") of space], otherwise burns or damage could result.

**Replacement of the lamp is better to be carried out by a qualified technician.**

- The lamp has high internal pressure. If improperly handled, explosion might result.
- The lamp can easily become damaged if struck against hard objects or dropped, and injury or malfunctions may result.

**When replacing the lamp, allow it to cool for at least one hour before handling it.**

- The lamp cover gets very hot, and touching it can cause burns.

**Before replacing the lamp, be sure to disconnect the power cord plug from the wall outlet.**

- Electric shocks or explosions can result if this is not done.

**Do not allow infants or pets to touch the remote control unit.**

- The accessory remote control unit can be used to operate not only the projector but also other appliances such as air conditioners and electrical device by programming them using the learning function. If the remote control unit operated inappropriately, fire or injury may result.
- Keep the remote control unit out of the reach of infants and pets after using it.

## Precautions with regard to safety

### CAUTIONS

#### Do not cover the air inlet port or the air outlet port.

- Doing so may cause the projector to overheat, which can cause fire or damage to the projector.
- Do not place the projector in narrow, badly ventilated places such as closets or bookshelves.
- Do not place the projector on cloth or papers, as these materials could be drawn into the air inlet port.

#### Do not set up the projector in humid or dusty places or in places where the projector may come into contact with oily smoke or steam.

- Using the projector under such conditions may result in fire, electric shocks or plastic deterioration. The plastic deterioration may cause the falling down of the projector which is mounted in the ceiling.

#### When disconnecting the power cord, hold the plug, not the cord.

- If the power cord itself is pulled, the cord will become damaged, and fire, short-circuits or serious electric shocks may result.

#### Always disconnect all cables before moving the projector.

- Moving the projector with cables still attached can damage the cables, which could cause fire or electric shocks to occur.

#### Do not place any heavy objects on top of the projector.

- Failure to observe this may cause the projector to become unbalanced and fall, which could result in damage or injury.

#### Do not short-circuit, heat or disassemble the batteries or place them into water or fire.

- Failure to observe this may cause the batteries to overheat, leak, explode or catch fire, and burns or other injury may result.

#### When inserting the batteries, make sure the polarities (+ and -) are correct.

- If the batteries are inserted incorrectly, they may explode or leak, and fire, injury or contamination of the battery compartment and surrounding area may result.

#### Use only the specified batteries.

- If incorrect batteries are used, they may explode or leak, and fire, injury or contamination of the battery compartment and surrounding area may result.

**We are constantly making efforts to preserve and maintain a clean environment. Please take non repairable units back to your dealer or a recycling company.**

#### Do not mix old and new batteries.

- If the batteries are inserted incorrectly, they may explode or leak, and fire, injury or contamination of the battery compartment and surrounding area may result.

#### Do not put your weight on this projector.

- You could fall or the projector could break, and injury may result.
- Be especially careful not to let young children stand or sit on the projector.

#### If not using the projector for an extended period of time, disconnect the power cord plug from the wall outlet.

- If dust builds up on the power cord plug, the resulting humidity may damage the insulation, which could result in fire.

#### Disconnect the power cord plug from the wall outlet as a safety precaution before carrying out any cleaning.

- Electric shocks can result if this is not done.

#### If the lamp has broken, ventilate the room immediately. Do not touch or bring your face close to the broken pieces.

- Failure to observe this may cause the user to absorb the gas which was released when the lamp broke and which contains nearly the same amount of mercury as fluorescent lamps, and the broken pieces may cause injury.
- If you believe that you have absorbed the gas or that the gas has got into your eyes or mouth, seek medical advice immediately.
- Ask your dealer about the replacement of the lamp unit and check the inside of the projector.

#### Ask an Authorized Service Center to clean inside the projector at least once a year.

- If dust is left to build up inside the projector without being cleaned out, it can result in fire or problems with operation.
- It is a good idea to clean the inside of the projector before the season for humid weather arrives. Ask your nearest Authorized Service Center to clean the projector when required. Please discuss with the Authorized Service Center regarding cleaning costs.



# Before use

## Accessories

Make sure the following accessories are provided with your projector.

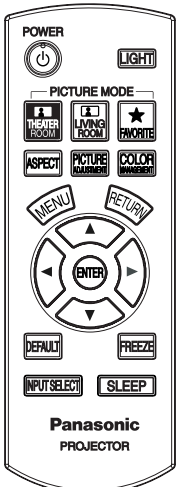
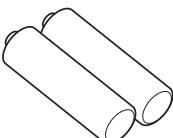
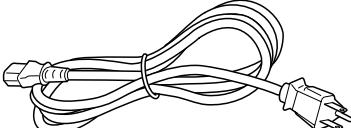
<p><b>Remote control</b> (N2QAYB000064 x 1)</p> 	<p>AA batteries for <b>Remote control</b> (x 2)</p>  <p><b>Power cord</b> for continental Europe (K2CG3FR00001 x 1)</p> 
---	--

## Cautions when transporting

**Do not subject the projector to excessive vibration or shocks.**

- The projector lens need to be handled with care.
- Cover the lens with the lens cover when transporting the projector.

## Cautions when installing

**Avoid setting up in places which are subject to vibration or shocks.**

- The internal parts can be damaged, which may cause malfunctions or accidents.

**Avoid setting up in places which are subject to sudden temperature changes, such as near an air conditioner.**

- The life of the lamp may be shortened or the projector may be turned off. See “TEMP indicator” on page 36.

**Do not set up the projector near high-voltage power lines or near motors.**

- The projector may be subject to electromagnetic interference.

**If installing the projector to the ceiling, ask a qualified technician to carry out all installation work.**

- You will need to purchase the separate installation kit (Model No. ET-PKX100). Furthermore, all installation work should only be carried out by a qualified technician.

**If using this projector at high elevations (above 1 400 m), set the ALTITUDE to HIGH. See “ALTITUDE” on page 35.**

- Failure to observe this may result in malfunctions or the life of the lamp or the other components may be shortened.

## Before use

## Cautions on use

### In order to get the best picture quality

- Draw curtains or blinds over any windows and turn off any lights near the screen to prevent outside light or light from indoor lamps from shining onto the screen.

### Do not touch the surfaces of the lens with your bare hands.

- If the surface of the lens becomes dirty from fingerprints or anything else, this will be magnified and projected onto the screen. Moreover, when not using the projector, cover it with the lens cover.

### Screen

- Do not apply any volatile substances which may cause discoloration to the screen, and do not let it become dirty or damaged.

### Lamp

- The lamp may need to be replaced earlier due to variables such as individual lamp characteristics, usage conditions and the installation environment, especially when the projector is subjected to continuous use for more than 10 hours or the power is frequently turned on and off.

### Liquid crystal panel

- Do not project the same image for long periods of time, as this may remain as an afterimage on the liquid crystal panel.
- The liquid crystal panel of the projector is built with very high precision technology to provide fine picture details. Occasionally, a few stuck pixels may appear on the screen as fixed points of blue, green or red. Please note that this does not affect the performance of your LCD.

# About Your Projector

## Remote control

### Front, back and top view

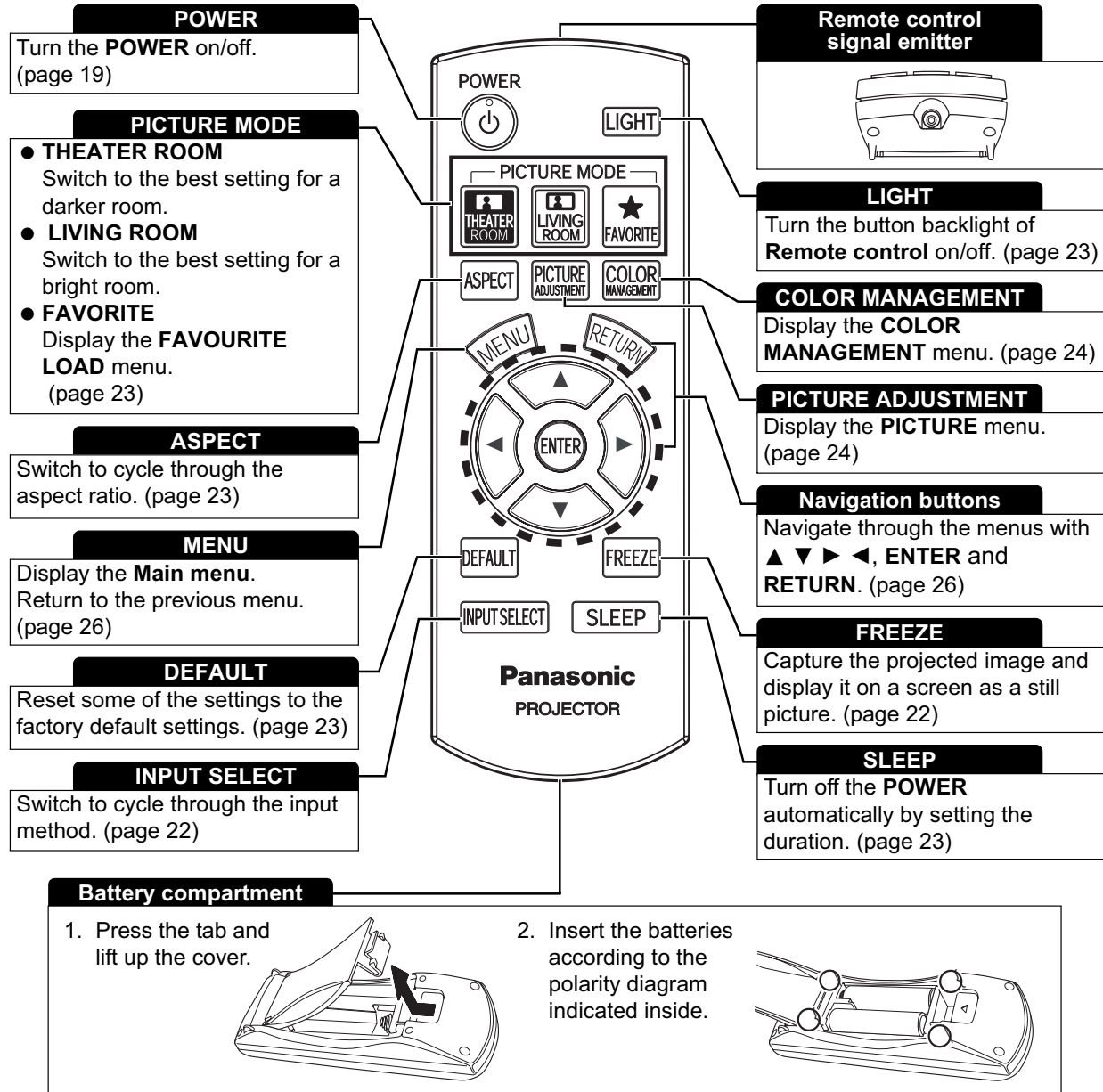

#### NOTE:

- Do not drop the **Remote control**.
- Avoid contact with liquids or moisture.
- Remove the batteries if not using the **Remote control** for a long period of time.
- Do not use rechargeable batteries.
- Do not keep pressing the **Remote control** buttons as this may shorten battery life.

# About Your Projector

## Projector

### Top and front view

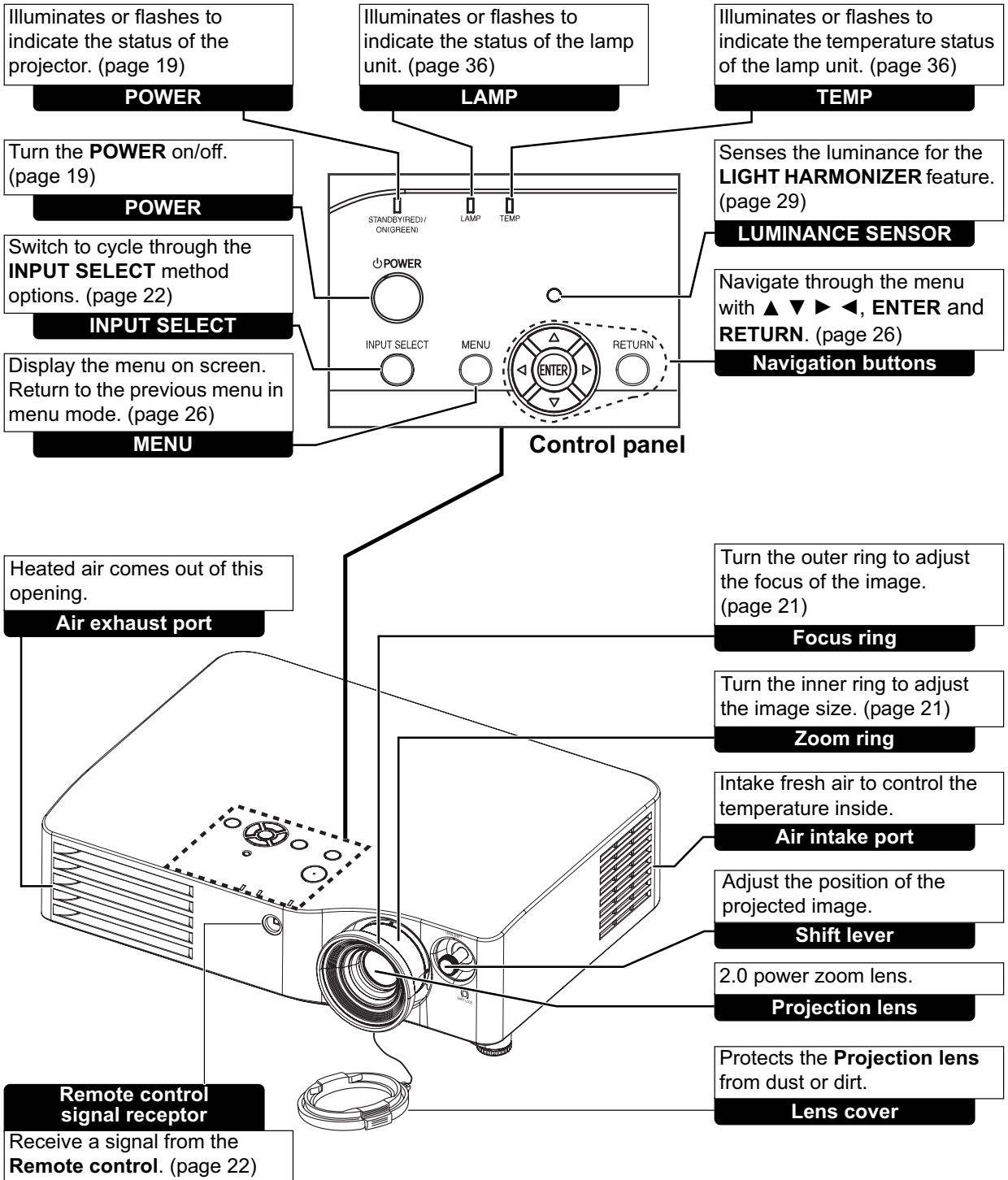

**NOTE:**

- Do not cover the ventilation openings or place anything within 10 cm (4") of them as this may cause damage or injury.
- While the projector is not in use, attach the **Lens cover** to protect the lens.

## Back and bottom view

Connect an RS-232C compatible cable for controlling the projector remotely via your PC.

### SERIAL

Connect an RGB signal cable from your PC.

### PC IN

Connect a YPBPR signal cable.

### COMPONENT IN

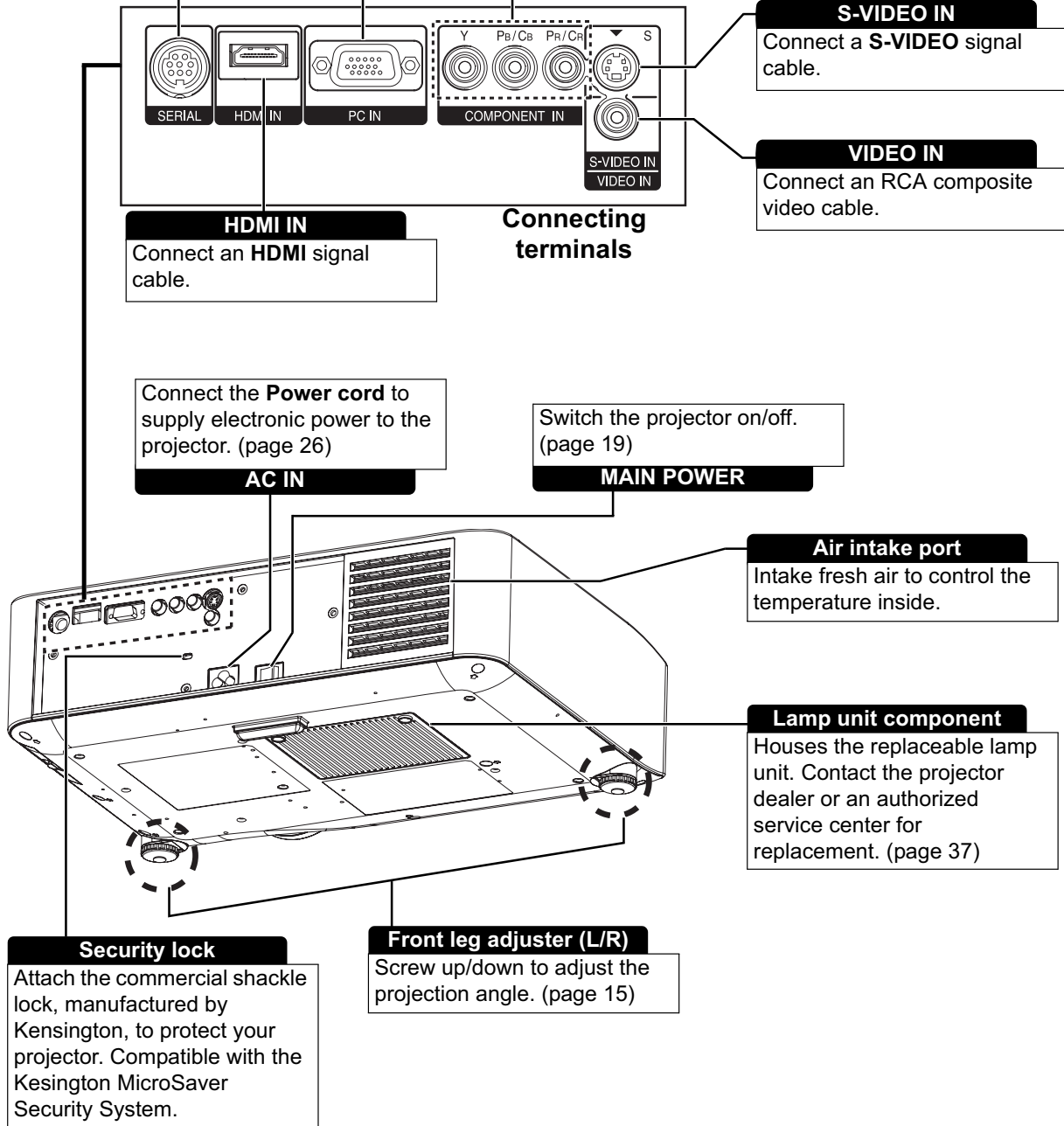

### NOTE:

- Do not cover the ventilation openings or place anything within 10 cm (4") of the vents as this may cause damage or injury.
- This projector should only be used with the attached **Power cord** to ensure optimum performance and avoid damage to the projector.

# Setting up

## Screen size and throw distance

You can adjust the projection size with 2.0 power zoom lens. Calculate and define the throw distance as follows.

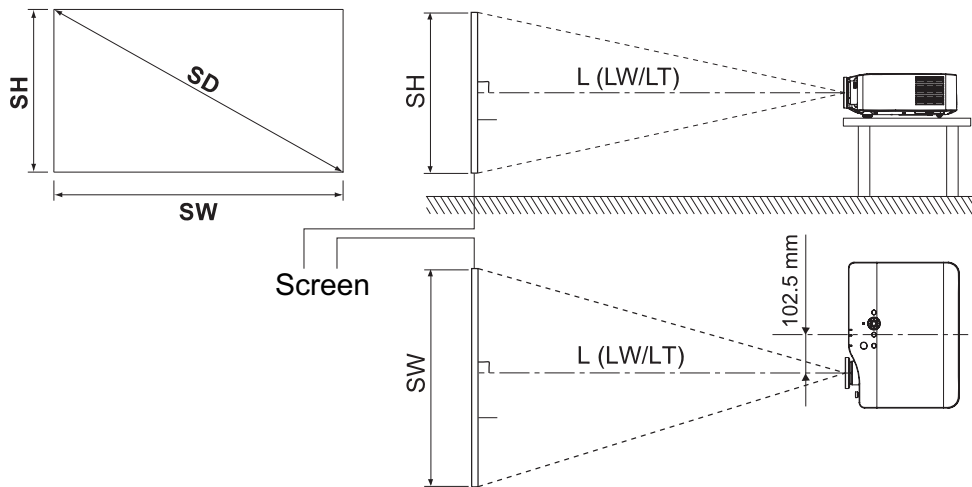

Getting Started

Projection size (16 : 9)			Throw distance (L)	
Diagonal length (SD)	Screen height (SH)	Screen width (SW)	Minimum distance (LW)	Maximum distance (LT)
1.01 m (40")	0.50 m (1'7")	0.89 m (2'11")	1.2 m (3'11")	2.4 m (7'10")
1.27 m (50")	0.62 m (2')	1.11 m (3'7")	1.5 m (4'11")	3.0 m (9'10")
1.52 m (60")	0.75 m (2'5")	1.33 m (4'4")	1.8 m (5'10")	3.7 m (12'1")
1.77 m (70")	0.87 m (2'10")	1.55 m (5'1")	2.1 m (6'10")	4.3 m (14'1")
2.03 m (80")	1.00 m (3'3")	1.77 m (5'9")	2.4 m (7'10")	4.9 m (16')
2.28 m (90")	1.12 m (3'8")	1.99 m (6'6")	2.7 m (8'10")	5.5 m (18')
2.54 m (100")	1.24 m (4')	2.21 m (7'3")	3.1 m (10'2")	6.2 m (20'4")
3.05 m (120")	1.49 m (4'10")	2.66 m (8'8")	3.7 m (12'1")	7.4 m (24'3")
3.81 m (150")	1.87 m (6'1")	3.32 m (10'10")	4.6 m (15'1")	9.3 m (30'6")
5.08 m (200")	2.49 m (8'2")	4.43 m (14'6")	6.2 m (20'4")	12.4 m (40'8")

\* All measurements above are approximate and may differ slightly from the actual measurements.

### Calculation methods for screen dimensions

You can calculate more detailed screen dimensions from the screen diagonal.

$$SW = SD \times 0.872$$

$$SH = SD \times 0.490$$

$$LW = 1.2244 \times SD - 0.056$$

$$LT = 2.4449 \times SD - 0.056$$

Unit: m

\* The results above are approximate and may differ slightly from the actual measurements.

#### NOTE:

- Do not use the projector at a raised or a horizontally tilted position as it may cause malfunction of the projector.
- Make sure the projector lens surface is parallel with the screen. You can tilt the projector body approximately  $\pm 30$  degrees vertically. Overtilting may result in shortening the component's life.
- For the best quality of the projection image, install a screen where sun light or room light does not shine directly onto the screen. Close window shades or curtains to block the lights.

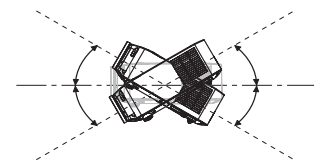

## Projection method

You can use the projector with any of the following 4 projection methods. To set the desired method in the projector, see "INSTALLATION" on page 35.

### ■ Setting on a desk/floor and projecting from front

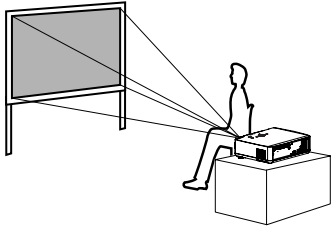

INSTALLATION: FRONT/DESK

### ■ Setting on a desk/floor and projecting from rear

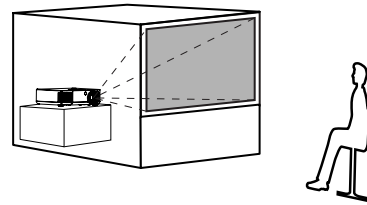

INSTALLATION: REAR/DESK

### ■ Mounting in the ceiling and projecting from front

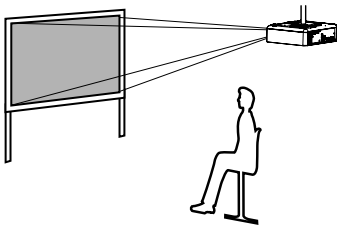

INSTALLATION: FRONT/CEILING

### ■ Mounting in the ceiling and projecting from rear

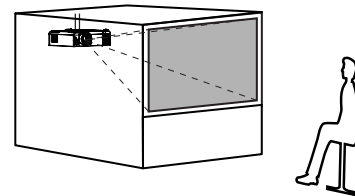

INSTALLATION: REAR/CEILING

#### NOTE:

- A translucent screen is required for **REAR** projection.
- When mounting the projector in the ceiling, the optional ceiling mount bracket (ET-PKX100) is required.

## Front leg adjuster and throwing angle

You can adjust the throwing angle by screwing the front legs up/down. This adjust the angle of the projector.

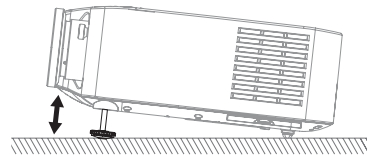
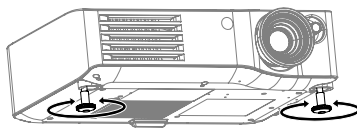

#### NOTE:

- Heated air comes out of the **Air exhaust port**. Do not touch the **Air exhaust port** directly.
- If keystone distortion occurs, see "KEYSTONE" on page 33.

## Lens shift and positioning

If the projector is not positioned right in front of the center of the screen, you can adjust the projected image position by moving the **Shift lever** within the shift range of the lens.

### ■ Adjusting the Shift lever

1. Screw the **Shift lever** counterclockwise to unlock.

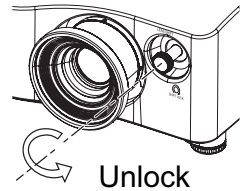

2. Move the **Shift lever** to adjust the projected image position
3. Screw the **Shift lever** clockwise to lock.

### ● Horizontal shift

You can place the projector where the projector lens is up to 25% horizontally off-center from the screen and then adjust the image position with the **Lens shift** feature.

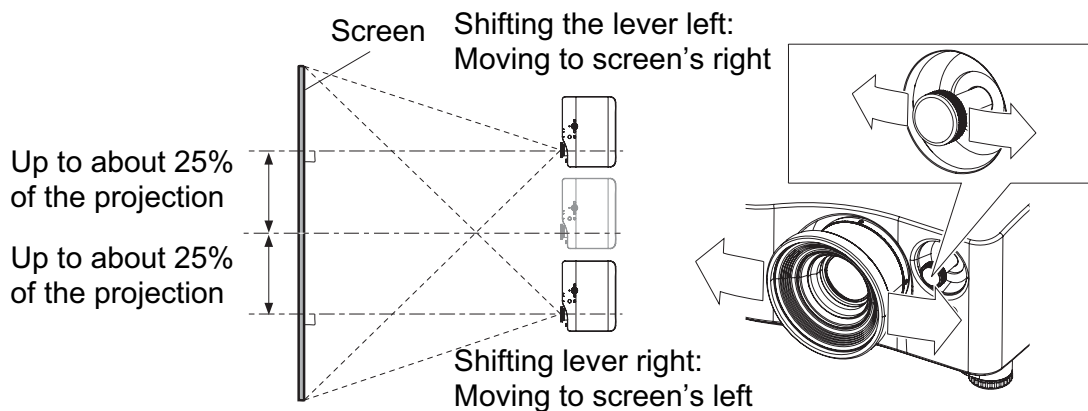

### ● Vertical shift

You can place the projector where the projector lens is up to 63% vertically off-center from the screen and then adjust the image position with the **Lens shift** feature.

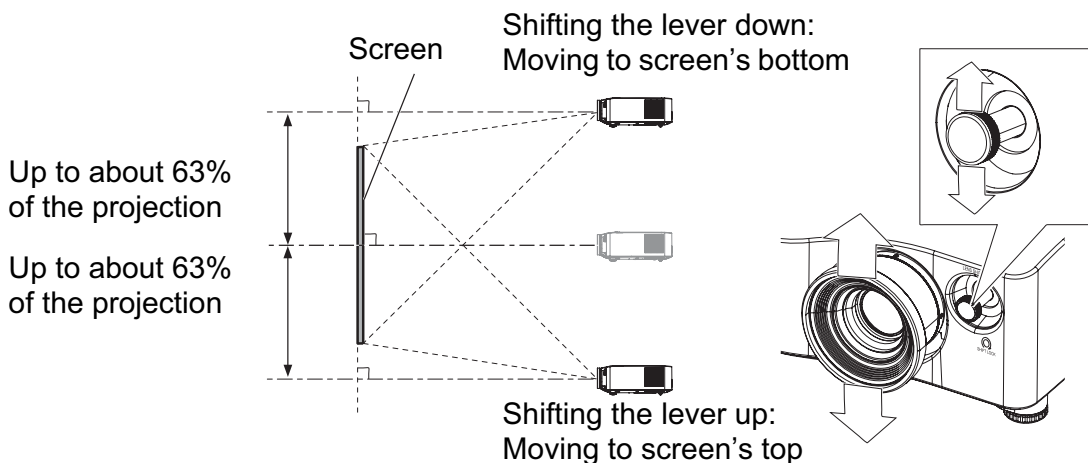



## Projector location range

You can determine where to locate the projector by considering the **Lens shift** possibilities. See “Positioning the image” on page 21 for available placement.

### After fixing the screen position

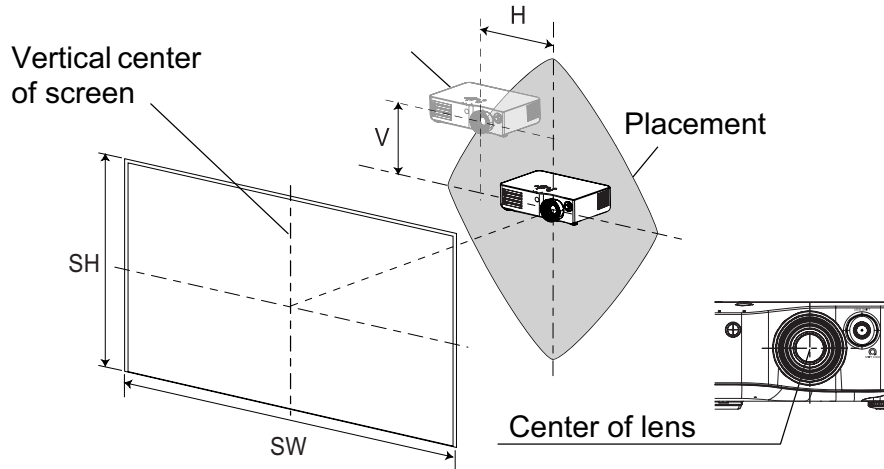

### The adjustable projection range

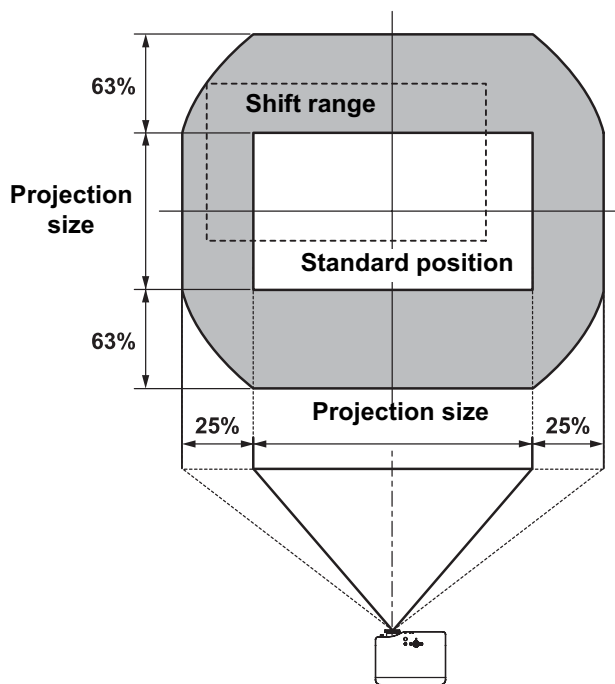

**NOTE:**

- When the projector is located right in front of the screen and the **Shift lever** is centered, you will get the best quality of the projection image.
- When the **Shift lever** is at the vertical limit of the shift range, you cannot move the lever to the horizontal limit, likewise when the **Shift lever** is at the horizontal limit of the shift range, you cannot move the lever to the vertical limit.
- When the projector is tilting and you adjust **KEYSTONE**, the center of the screen and the lens need to be realigned.
- Do not attempt to pull hard the **Shift lever** while adjusting.

# Connections

## Before connection to the projector

- Read and follow the operating and connecting instructions of each peripheral device.
- The peripheral devices must be turned off.
- Use cables that match each peripheral device to be connected.
- Confirm the type of video signals. See “List of compatible signals” on page 41.
- Audio cables must be connected from each peripheral device directly to the audio reproduction system.

## Connecting with AV devices

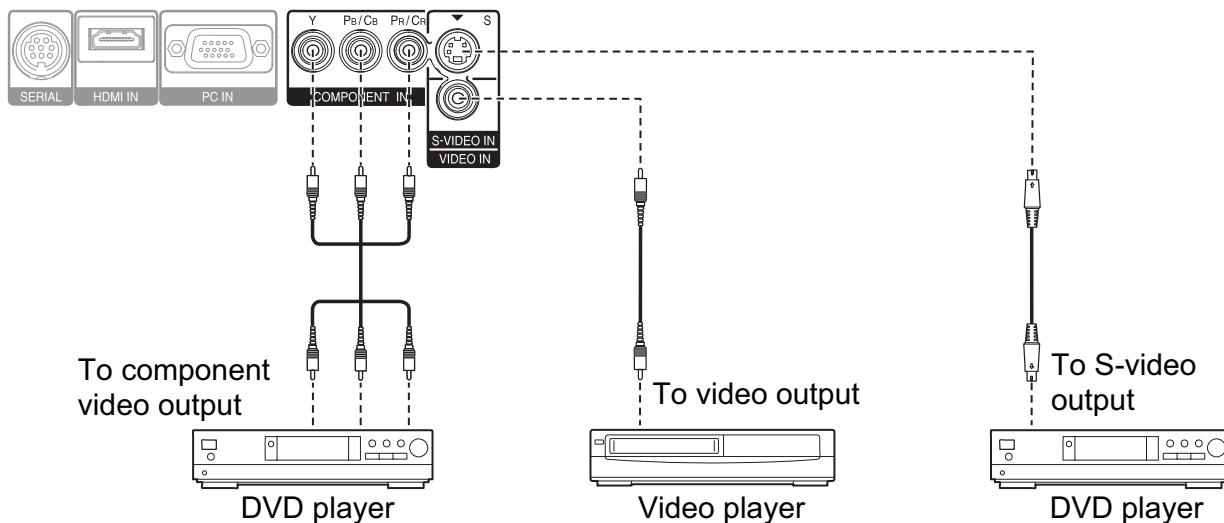

## Connecting with HDMI/PC

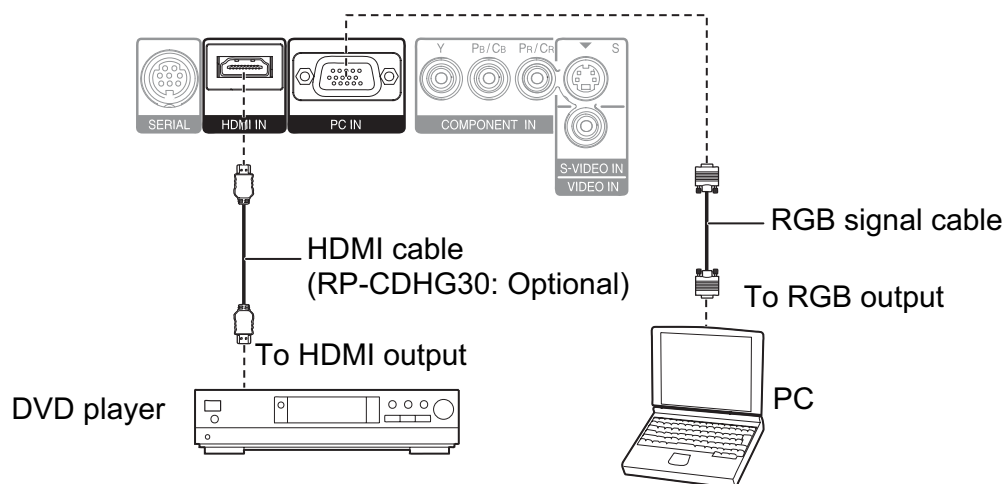

### NOTE:

- Make sure the **HDMI** cable is adapted to your **HDMI** device for proper performance.
- A compatible cable is required for an HDMI 1 080p signal.
- It is possible to connect with DVI devices via a HDMI/DVI conversion adapter, but some equipment may not project the image properly or other problems could be encountered. See “Serial terminal” on page 42.

# Switching the projector on/off

## Power cord

Ensure all the input devices are connected and turned off before connecting the **Power cord**.

### ■ Connecting

1. Make sure the shape of the power cord plug and the **AC IN** connector on the back of the projector match, then push the plug all the way in.
2. Connect the **Power cord** to a wall socket.

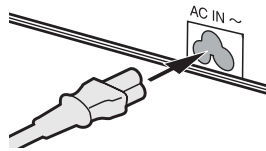

### ■ Disconnecting

1. Make sure the **MAIN POWER** is switched off and unplug the **Power cord** from the wall socket.
2. Hold the plug and unplug the **Power cord** from the **AC IN** connector on the back of the projector.

#### NOTE:

- Do not use any other **Power cord** than the one supplied with the projector.
- Do not force the connector as this may damage the projector and/or the power cord.
- Dirt or dust build-up around plugs may cause fire or electrical hazards.
- Switch off the power to the projector when not in use.

## POWER indicator

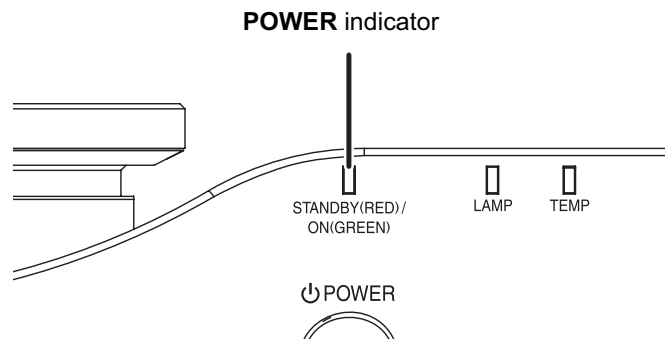

Indicator status		Status
No illumination or flashing		The <b>MAIN POWER</b> is switched off.
<b>RED</b>	<b>Lit</b>	The <b>MAIN POWER</b> is switched on and the projector is standby.
<b>GREEN</b>	<b>Flashing</b>	The <b>POWER</b> is switched on and the projector is getting ready to project.
	<b>Lit</b>	The projector is ready to project.
<b>ORANGE</b>	<b>Lit</b>	The <b>POWER</b> is switched off and the projector is cooling the lamp.
	<b>Flashing</b>	The <b>POWER</b> is switched on again when cooling the lamp and recovering to projection mode. Recovery may take a while.

#### NOTE:

- While the projector is cooling the lamp, do not switch the **MAIN POWER** off or unplug the **Power cord**.

## Switching the projector on/off

### Switching on the projector

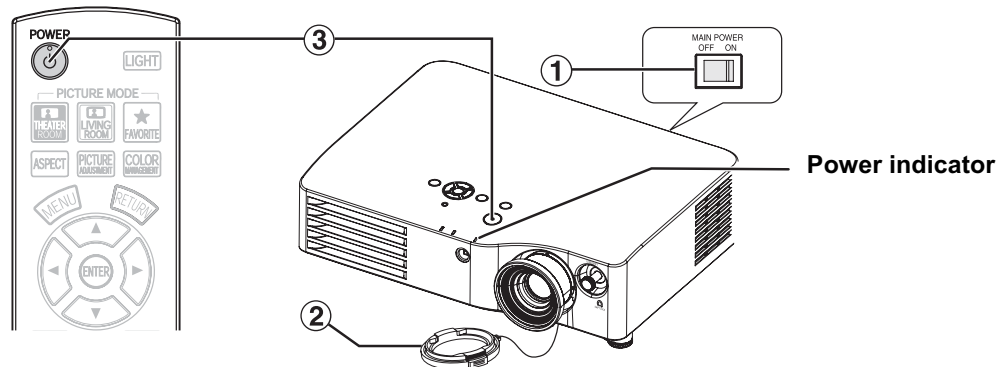

1. Switch the **MAIN POWER** on.
  - The power indicator lights up in **RED**.
2. Remove the **Lens cover** from the lens.
3. Press the **POWER** button.
  - The power indicator lights up in **GREEN** after flashing for a while.  
The **STARTUP LOGO** is displayed on the screen.

#### NOTE:

- See page 34 about switching on/off the **STARTUP LOGO**.
- Some small rattling or tinkling sound may be heard when starting up, but this is normal and does not affect the performance of the projector.

### Switching off the projector

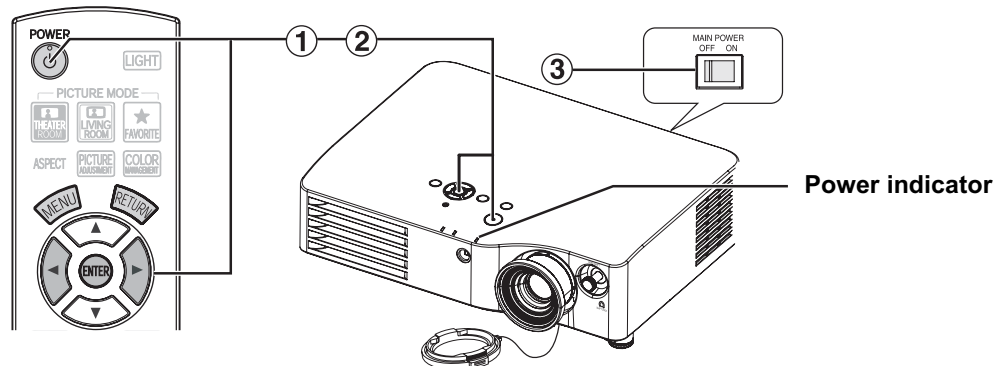

1. Press the **POWER** button.
  - The confirmation screen is displayed.
  - To return to the projection, press **ENTER** to select **CANCEL** or press **MENU/RETURN**.
2. Press ◀ to select **OK** and press **POWER** or **ENTER**.
  - The power indicator lights up in **ORANGE** while cooling the lamp, then illuminates **RED** when it is ready to switch off the **MAIN POWER**.
3. Switch off the **MAIN POWER** on the back of the projector.

#### NOTE:

- Press the **POWER** twice or for a long duration to switch the power.

# Projecting an image

## Selecting the input signal

1. Switch on the connected devices.
  - Press the play button of the required device.
2. Press the **INPUT SELECT** button to select the required input method if needed. See "Input switching" on page 22.
  - The image will be projected on the screen.

### NOTE:

- **AUTO SEARCH** is **ON** as default and the signal from the connected devices is detected automatically. See "AUTO SEARCH" on page 34.

## Positioning the image

1. Press **ASPECT** to select the required aspect mode. See "ASPECT" on page 32.
2. Adjust the projected image with the **Shift lever**. See "Lens shift and positioning" on page 16.
4. Adjust the focus and the projected image size.
  - Turn the **Focus ring** and **Zoom ring** to adjust the image.
  - You can confirm the result with **TEST PATTERN**.

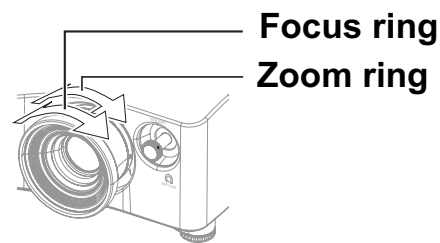
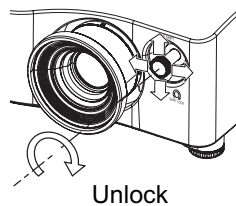

3. Adjust the angle of the projector.
  - Screw down the **Front leg adjuster** and adjust the angle vertically.

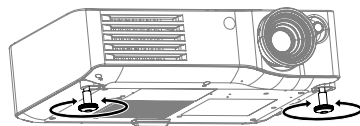

### NOTE:

- Do not touch the **Air exhaust port** as this may cause burns or injury.
- If keystone distortion occurs, see "KEYSTONE" on page 33.

# Remote control operation

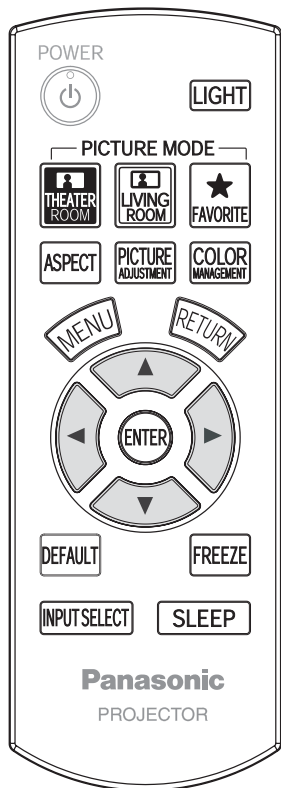

## Operating range

You can operate the projector with the **Remote control** within the remote range 7 m.

### ● Facing to the projector

Ensure the **Remote control emitter** is facing to the **Remote control signal receptor** on front of the projector and press the required buttons to operate.

### ● Facing to the screen

Ensure the **Remote control emitter** is facing to the screen and press the required buttons to operate the projector. The signal will be reflected off the screen. The operating range may differ due to the screen material.

#### NOTE:

- The **Remote control** may malfunction under strong light such as a fluorescent. Do not let strong light shine onto the signal receptor.
- If there are any obstacles in between the remote control unit and the receptor, the **Remote control** may not operate correctly.

## Input switching

### INPUT SELECT

You can switch the input method manually by pressing the **INPUT SELECT** button. Press the button several times or press ◀ ▶ to cycle through the input methods as follows. The actual projected image will be changed in a while.



<b>COMPONENT IN</b>	Connected to <b>COMPONENT IN</b> terminal equipment's signal
<b>S-VIDEO IN</b>	Connected to <b>S-VIDEO IN</b> terminal equipment's signal
<b>VIDEO IN</b>	Connected to <b>VIDEO IN</b> terminal equipment's signal
<b>HDMI IN</b>	Connected to <b>HDMI</b> terminal equipment's signal
<b>PC IN</b>	Connected to <b>PC IN</b> terminal equipment's signal

Graphical guidance will be displayed on the upper right of the display and you can confirm the selected input method which is highlighted in yellow. See "INPUT GUIDE" on page 34.

#### NOTE:

- If you select an unplugged input method, the guidance will blink on and off several times.
- See "List of compatible signals" on page 41.
- See "Connecting terminals" on page 13.

## Capturing an image

### FREEZE

When projecting an image, press **FREEZE** to capture the projected image and display it on the screen as a still picture. Press again to escape.

#### NOTE:

- Escaping from the freeze mode is available by pressing any button except the **LIGHT** button.

## Switching the aspect ratio

**ASPECT**

The aspect ratio is selected automatically, or you can switch it manually by pressing the **ASPECT** button. Press the button several times to cycle through the different aspect type as follows. See "ASPECT" on page 32.

VIDEO/ S-VIDEO/ COMPONENT (YPbPr)	4:3    ◀▶    16:9    ◀▶    14:9
	▲▼    ▲▼
	ZOOM2    ◀▶    ZOOM1    ◀▶    JUST
PC (RGB)	4:3    ▶    16:9
	▲▼    ▲▼
	V SCROLL
HDMI	4:3    ▶    16:9

**NOTE:**

- If you project an image with an unmatched aspect ratio, the image may distort or some portions may be cropped. Select an aspect ratio which preserves the intention of the image creator.
- The order of **ASPECT** types is defined not only by the input method but also by the input signals. See "List of compatible signals" on page 41.
- If you project a copyrighted image enlarged or distorted by using **ASPECT** function in commercial use in a public place, such as a restaurant or hotel, you might infringe on the copyright of the creator which is protected by copyright law.

## Switching off the projector automatically

**SLEEP**

You can switch off the **POWER** automatically by setting the **SLEEP** feature. Press the **SLEEP** button several times to cycle through the duration of time. See "SLEEP" on page 35.

OFF	▶	60MIN.	▶	90MIN.	▶	120MIN.
▲▼						▲▼
240MIN.	▶	210MIN.	▶	180MIN.	▶	150MIN.

## Resetting to the factory default settings

**DEFAULT**

You can reset most of the customized settings to the factory defaults by pressing **DEFAULT** button of the **Remote control**. Display the required sub menu or the menu items and press the button again.

**NOTE:**

- Some menu items are not available to reset by pressing the **DEFAULT** button. Adjust each menu items manually.



## Turning on the button backlight

**LIGHT**

In a dark room, you can turn on the button backlight to operate the **Remote control**. Press the button on the upper right corner of the unit to turn on the backlight and enter the light-on mode. After 5 seconds without any operation, the backlight is faded, and it will go out after another 5 seconds. Press any but **LIGHT** to turn on again. To escape from the light-on mode, press the **LIGHT** button.

## Switching the picture mode

You can switch the preset settings by pressing the **THEATER ROOM**, **LIVING ROOM** and **FAVORITE** buttons. See "PICTURE MODE" on page 28.

	CINEMA1    ▶    CINEMA2
	▲▼    ▲▼
	NATURAL    ▶    VIDEO
	NORMAL    ▶    DYNAMIC
	▲▼    ▲▼
	VIVID CINEMA
	Display the <b>FAVOURITE LOAD</b> menu. See "FAVOURITE LOAD" on page 30.

# Remote control operation

## Adjusting the image



You can display one of the **PICTURE** or **ADVANCED** menu items by pressing the **PICTURE ADJUSTMENT** button. Press the button to switch between **PICTURE** and **ADVANCED** menu. Press **▲ ▼** to select the required menu item and **◀ ▶** to adjust.

- **PICTURE menu items**  
**PICTURE MODE, CONTRAST, BRIGHTNESS, COLOR, TINT, SHARPNESS, COLOR TEMPERATURE** and **DYNAMIC IRIS**
- **ADVANCED menu items**  
**GAMMA, CONTRAST, BRIGHTNESS, COLOR MANAGEMENT, NR, MPEG NR, CINEMA REALITY** and **TV-SYSTEM**

### NOTE:

- For each menu items description, see "Menu Navigation" on page 26.
- The screen will be cleared after 7 seconds without any operation.

## Setting your own color profile



You can adjust a selected color individually and save and retrieve under the **PICTURE MODE** setting. Press the **COLOR MANAGEMENT** button to open the menu.

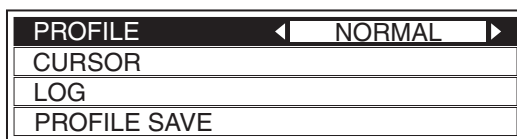

## Create a new profile

### ● Adjusting the selected color

Select a color and adjust **COLOR, TINT** and **BRIGHTNESS**.

1. Select the **CURSOR** menu and press **ENTER**.
  - The projected image is captured, and the target cursor is displayed.
  - When the **LOG** is fully stored, the target cursor will not be displayed. See "Managing stored logs" on page 25.

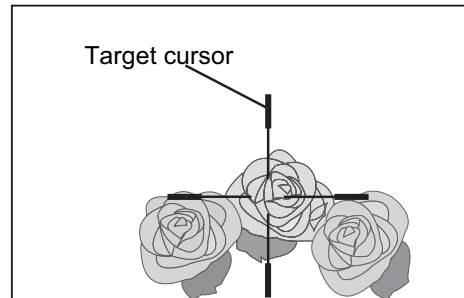

2. Move the cursor with **▲ ▼ ◀ ▶** to the required place to select a color and press **ENTER**.

- The color at the center of the target cursor is sampled and the sample box is displayed on the left of the cursor. The menu items are displayed on the upper part of the screen.

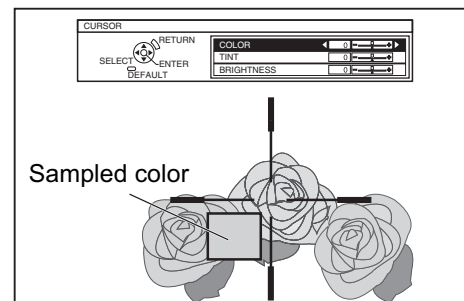

3. Select a menu item and the **◀ ▶** to adjust each item level.

- The result box is displayed on the right of the cursor and shows the adjusted color.

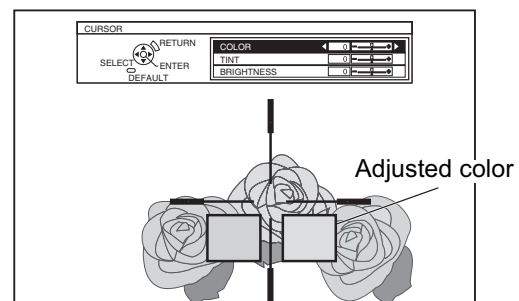



<b>COLOR</b>	Adjust the vividness of the color. Setting range: -30 to +30 Default: 0
<b>TINT</b>	Adjust the color tone. Setting range: -30 to +30 Default: 0
<b>BRIGHTNESS</b>	Adjust the brightness of the color. Setting range: -20 to +20 Default: 0

- Press **ENTER** to store the adjusted result.
  - **"PROCESSING"** is displayed for a few seconds and the result is stored in **LOG**.
  - You can store up to 8 logs under **LOG** for each **PICTURE MODE** setting.
- Press **MENU** or **RETURN** to return to the previous menu.
  - Repeat the steps above to store more adjustment.

## Managing stored logs

You can edit or delete the stored logs of the selected **PICTURE MODE**.

- Select **LOG** and press **ENTER**.
  - The **LOG** menu is displayed.

PICTURE MODE : CINEMA1			
POINT1	0	0	+2
POINT2	-1	0	-2
POINT3	0	+10	0
POINT4	-10	+10	-10
POINT5	-6	+5	+7
POINT6	+3	-3	+1
POINT7	0	+7	+9
POINT8	-1	+14	-4
ALL DELETE			

Sampled color  Adjusted color

- Select the required log from 1 - 8 or **ALL DELETE**, and press **ENTER**.
  - Select **CHANGE** to edit the log.  
The cursor menu is displayed and you can readjust the color.
  - Select **DELETE** to delete the log.  
The confirmation screen will be displayed. Select **OK** to delete.
  - When you select **ALL DELETE**, the **"DELETE ALL LOG."** screen is displayed. Select **OK** to delete all logs. The **PROFILE** setting will be set to **NORMAL**.

## Saving a log setting as a profile

Return to the **COLOR MANAGEMENT** menu and save the stored log as a profile. Make sure that the **PICTURE MODE** is not switched.

- Select the **PROFILE SAVE** menu and press **ENTER**

- The **PROFILE SAVE** menu is displayed. You can save the profile as **USER1**, **USER2** and **USER3**.

USER1
USER2
USER3

- Press **ENTER** to save the profile
  - The confirmation screen is displayed. Press **ENTER** again to save.

## Loading saved profiles

When profiles are loaded under the **PICTURE MODE** setting, you can keep them as you defined until the **PROFILE** is set to **NORMAL**.

- Select the required **PICTURE MODE** and press **ENTER**.
- Press the **COLOR MANAGEMENT** button and select the **PROFILE** menu.
  - The profile settings of the selected **PICTURE MODE** will be displayed.
- Select the required profile and press **ENTER**.

<b>NORMAL</b>	Return to the default setting of the <b>PICTURE MODE</b>
<b>USER1</b>	Defined profile settings.
<b>USER2</b>	
<b>USER3</b>	

### NOTE:

- **LOG** and **PROFILE SAVE** are not displayed before you apply **COLOR MANAGEMENT**.
- If you load a profile with a different attribute mode of the profile, the **CURSOR** and **PROFILE SAVE** menus will not be displayed.
- The approximate colors will be adjusted at the same time. If you adjust the exact same color differently, both colors will affect each other and you might get unexpected results.
- White, Black and Grey are not adjustable.
- If you escape the **COLOR MANAGEMENT** menu or attempt to perform another menu action before you save the adjusted profile, the confirmation screen will be displayed.
- If you switch the input signal before you save the profile, the setting will be cancelled without notice.

# Menu Navigation

The menu system allows you to access functions which do not have their own dedicated buttons on the **Remote control**. The menu options are structured and categorized. You can navigate through the menu with ▲ ▼ ◀ ▶ buttons.

## Navigating through the MENU

### Displaying the Main menu



Press **MENU** button to display the **Main menu** and the operating guidance.

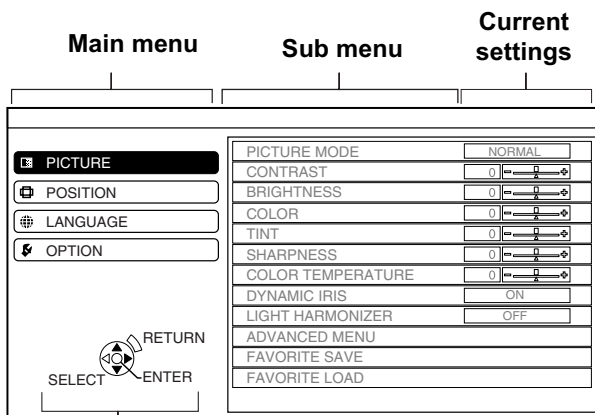

#### Operating guidance

Contains the required buttons to adjust the settings.

### Operating procedure

- Press ▲ ▼ to scroll to the required **Main menu** item and press **ENTER** to select.
  - The selected item is highlighted in orange and the **Sub-menu** is displayed on the right. See "Sub-menu" on page 27.
- Press ▲ ▼ to scroll to the required **Sub-menu** item and press ◀ ▶ or **ENTER** to adjust.
  - The selected item is called up and the other menu items disappear from the screen.
  - If there is a lower level, the next level will be displayed.

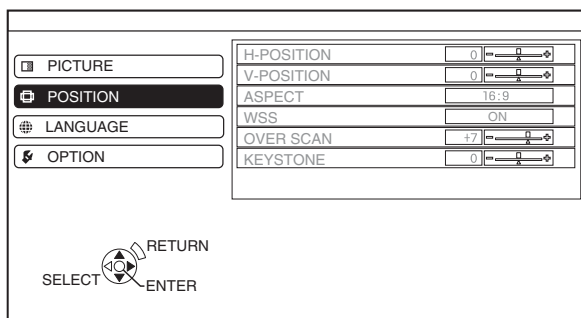

- Press ◀ ▶ to adjust or set the selected item.
  - For items using a bar scale, the current settings are displayed on the left of the bar scale.
  - You can cycle through the options of an item by pressing ◀ ▶.

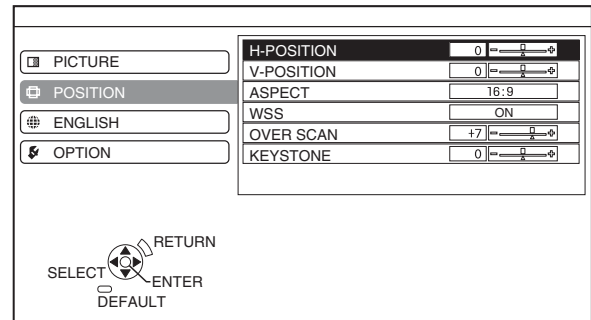

- Press **MENU** or **RETURN** to return to the previous menu.
  - To continue projection, press the button repeatedly until the menu disappears.

### About the bar scale items

The triangle mark under the bar indicates factory default setting and the square indicates the current setting.

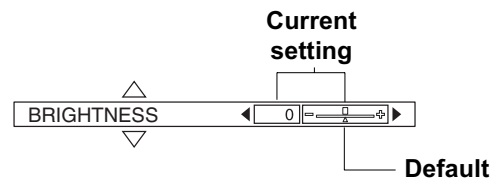

## Main menu

The **Main menu** has 4 options. Select the required option and press **ENTER** to display the **Sub-menu**.

	PICTURE
	POSITION
	LANGUAGE
	OPTION

## Sub-menu

Sub-menu items vary by the selected input signal.

### PICTURE menu

See "PICTURE Menu" on page 28.

Sub-menu items	Default setting <sup>1</sup>
PICTURE MODE	NORMAL
CONTRAST	0
BRIGHTNESS	0
COLOR	0
TINT	0
SHARPNESS	0
COLOR TEMPERATURE	0
DYNAMIC IRIS	ON
LIGHT HARMONIZER	AUTO
ADVANCED MENU	
FAVOURITE SAVE	
FAVOURITE LOAD	
SIGNAL MODE <sup>2</sup>	

1. The default settings vary by the selected PICTURE MODE.
2. PC/COMPONENT/HDMI signals only

### POSITION menu

See "POSITION Menu" on page 31.

Sub-menu items	Default setting
V - POSITION	0
H - POSITION	0
DOT CLOCK <sup>1</sup>	0
CLOCK PHASE <sup>2</sup>	0
ASPECT	AUTO <sup>3</sup>
WSS <sup>4</sup>	ON
OVER SCAN	+7
KEystone	ON
AUTO SETUP <sup>5</sup>	

1. PC signal only
2. COMPONENT/PC signals only
3. 16:9 for PC or HDMI signals
4. VIDEO/S-VIDEO/COMPONENT signals only
5. PC signal only

### LANGUAGE menu

Select the required language option.

1/2	
DEUTSCH	
FRANÇAIS	
ESPAÑOL	
ITALIANO	
PORTUGUÊS	
SVENSKA	
NORSK	
DANSK	

2/2	
POLSKI	
ČEŠTINA	
MAGYAR	
РУССКИЙ	
ไทย	
한국어	
<input checked="" type="radio"/> ENGLISH	
中文	

### OPTION menu

See "OPTION Menu" on page 34.

Sub-menu items	Default setting
INPUT GUIDE	DETAILED
OSD DESIGN	TYPE1
OSD POSITION	CENTRE
BACK COLOR	BLUE
STARTUP LOGO	ON
AUTO SEARCH	ON
INSTALLATION	FRONT/DESK
SLEEP	OFF
ALTITUDE	LOW
LAMP POWER	NORMAL
LAMP RUNTIME	
TEST PATTERN	

# PICTURE Menu

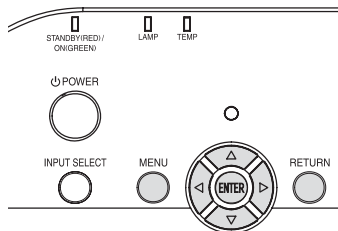
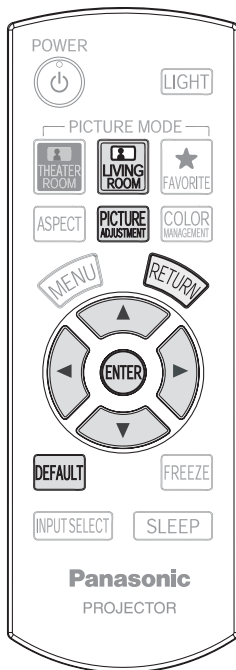

- See "Navigating through the MENU" on page 26.

## Reproducing color of an sRGB image

For reproducing the original color of **S-VIDEO** images precisely, set as follows.

1. Press **PICTURE ADJUSTMENT** and select **NATURAL**.
2. Press **DEFAULT** to reset the other **Sub-menu** menu items
3. Press **RETURN** once to return to the **Main menu** and select **OPTION**
4. Switch the **LAMP POWER** to **NORMAL**

### NOTE:

- It may take for a while until the selected mode is stabilized.

## CONTRAST

You can adjust the contrast of the projected image. Adjust the **BRIGHTNESS** in advance if necessary.



- Setting range: -32 to +32

## BRIGHTNESS

You can adjust the brightness of the projected image.



- Setting range: -32 to +32

## COLOR

You can adjust the color saturation of the projected image.



- Setting range: -32 to +32
- When **PC** is connected, this function is available with 1 125 (1 080)/60i, 1 125 (1 080)/50i, 1 125 (1 080)/60p and 1 125 (1 080)/50p signals only.

## PICTURE MODE

Depending on the projection environment, you can use these preset parameter settings to optimise image projection. Press ◀ ▶ to cycle through the options.

### For a bright room

<b>NORMAL</b>	Setting for a general image, such as sports or games
<b>DYNAMIC</b>	Bright and sharp setting
<b>VIVID CINEMA</b>	Vivid and crisp color setting

### For a dark room

<b>CINEMA1</b>	Hollywood style colors
<b>CINEMA2</b>	Deeper and more rich color setting
<b>VIDEO</b>	Setting for active images, such as music or concert
<b>NATURAL</b>	Reproduces the original color of the image

## TINT

You can adjust the skin tone in the projected image.



- Setting range: -32 to +32
- When PC is connected, this function is available with 1 125 (1 080)/60i, 1 125 (1 080)/50i, 1 125 (1 080)/60p and 1 125 (1 080)/50p signals only.

## SHARPNESS

You can adjust the sharpness of the projected image.



- Setting range is vary according to the selected input signal

## COLOR TEMPERATURE

You can adjust the white balance of the projected image.



- Setting range: -6 to +6

## DYNAMIC IRIS

You can switch automatic adjustment of the lamp and the lens iris on/off.

- **ON:** Automatic adjustment
- **OFF:** No adjustment

## LIGHT HARMONIZER

**LUMINANCE SENSOR** detects the brightness of the room and keeps the luminance in balance automatically. If needed, you can switch on/off this function or adjust it manually. Press ◀ ▶ to cycle through the options.



- **OFF** No adjustment
- **AUTO:** Automatic adjustment
- **MANUAL:** Manual adjustment (0 - +8)

### NOTE:

- To assure correct performance of the **LIGHT HARMONIZER**, do not interrupt the light onto the **LUMINANCE SENSOR**.

## ADVANCED MENU

From the **ADVANCED MENU**, you can perform more detailed image adjustment manually.

### GAMMA

You can adjust linear intensity at 3 levels. Press ◀ ▶ to increase/decrease.

Levels	Default setting
GAMMA HIGH	0
GAMMA MID	0
GAMMA LOW	0

- Setting range: -8 to +8

### CONTRAST

You can adjust the amount of contrast in RGB colors individually. Press ◀ ▶ to increase/decrease.

RGB	Default setting
CONTRAST R	0
CONTRAST G	0
CONTRAST B	0

- Setting range: -16 to +16

### BRIGHTNESS

You can adjust the brightness in RGB colors individually. Press ◀ ▶ to increase/decrease.

RGB	Default setting
BRIGHTNESS R	0
BRIGHTNESS G	0
BRIGHTNESS B	0

- Setting range: -16 to +16

### COLOR MANAGEMENT

You can manage your own defined color settings. See "Setting your own color profile" on page 24.

# PICTURE Menu

## NR (Noise Reduction)

You can switch the automatic noise reduction system on/off. Press ◀ ▶ to select the required setting.

- **ON:** Automatic noise reduction
- **OFF:** No noise reduction

**NOTE:**

- Applying noise reduction may affect image quality.

## MPEG NR

You can switch the automatic noise reduction system for MPEG format images on/off. The system minimizes block noise and mosquito noise to eliminate jagged edges, providing an overall smoother image. Press ◀ ▶ to select the required setting.

- **ON:** Active
- **OFF:** Deactive

**NOTE:**

- MPEG NR is for MPEG images only.
- MPEG NR is not available with PC and HDMI (VGA480) signals.

## CINEMA REALITY

You can switch the automatic image synchronizer on/off for 24 frames a second images, such as movies. Press ◀ ▶ to select the required setting.

- **ON:** Active
- **OFF:** Deactive

**NOTE:**

- **S-VIDEO, VIDEO, PC. COMPONENT** available signals are 525i (480i), 625i (576i), 1 125 (1 080)/50i, 1 125 (1 080)/60i, 1 125 (1 080)/50p and 1 125 (1 080)/60p, while **HDMI** available signals are 1 125 (1 080)/60i, 1 125 (1 080)/50i.
- If the **CINEMA REALITY** is different from the required setting of the image, select **OFF**.

## TV-SYSTEM

When the video signal is changed, the setting switches automatically.

You can switch the setting manually to match the video data. Press ◀ ▶ to cycle through the options.

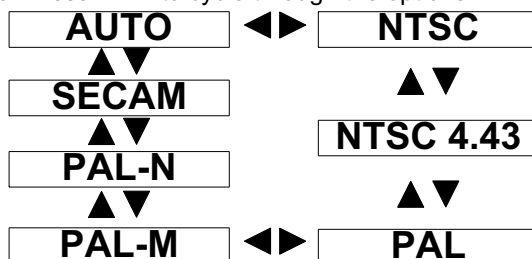

## FAVOURITE SAVE

You can save the adjusted **PICTURE** settings with up to 3 in each of 2 signal groups.

1. Adjust the different items of the **PICTURE** menu.
2. Select **FAVOURITE SAVE** and press **ENTER**.
3. Select **FAVOURITE 1**, **FAVOURITE 2** or **FAVOURITE 3** to save and press **ENTER**.
  - The confirmation screen is displayed.
4. Select **OK** and press **ENTER**.
  - To cancel, select **CANCEL** and press **ENTER**, or press the **RETURN** button.

<b>VIDEO, S-VIDEO, COMPONENT, HDMI (not including VGA480), 1 125 (1 080)/50i, 1 125 (1 080)/60i, 1 125 (1 080)/50p and 1 125 (1 080)/60p signals in PC connection</b>	<b>FAVOURITE 1 FAVOURITE 2 FAVOURITE 3</b>
<b>VGA480 in HDMI connection, PC not including 1 125 (1 080)/50i, 1 125 (1 080)/60i, 1 125 (1 080)/50p and 1 125 (1 080)/60p</b>	<b>FAVOURITE 1 FAVOURITE 2 FAVOURITE 3</b>

## FAVOURITE LOAD

You can access saved **FAVOURITE** settings instantly.

1. Select the required setting from **FAVOURITE 1**, **FAVOURITE 2** or **FAVOURITE 3**.
  - Undefined setting will not be displayed.
2. Press **ENTER** to activate the selected setting.

**NOTE:**

- If you have not saved any settings, **FAVOURITE 1**, **FAVOURITE 2** and **FAVOURITE 3** are not displayed.

## SIGNAL MODE

The current selected signal is displayed when **PC/COMPONENT/HDMI** equipment is connected.

**NOTE:**

- See "List of compatible signals" on page 41.

# POSITION Menu

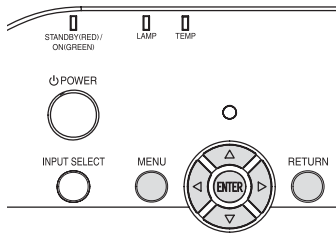
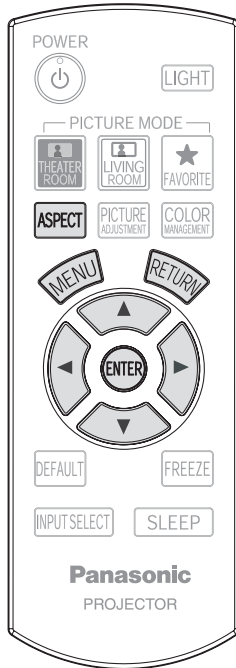

- See "Navigating through the MENU" on page 26.

## DOT CLOCK

If you have interference patterns on the projected image, which is sometimes referred to as moire or noise, you can minimize it by pressing ◀▶ to adjust the clock frequency.

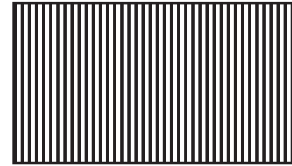

### NOTE:

- If the projecting signal's dot clock frequency is higher than 150 MHz, the adjustment may not make a difference.

## CLOCK PHASE

If you require further adjustment for the same reason as the **DOT CLOCK** adjustment, you can fine adjust the timing of the clock. Press ◀▶ to adjust.

### NOTE:

- If the projecting signal's dot clock frequency is higher than 150 MHz, the adjustment may not make a difference.
- **CLOCK PHASE** is not available with 1 125 (1 080)/50i, 1 125 (1 080)/60i, 1 125 (1 080)/50p, 1 125 (1 080)/60p, 1 125 (1 080)/24p, 750 (720)/50p and 750 (720)/60p signals using the **COMPONENT** connection.

## H - POSITION

You can move the projected image horizontally for fine adjustment.

Move  
left



Move  
right

## V - POSITION

You can move the projected image vertically for fine adjustment.

Move  
down



Move  
up

# POSITION Menu

## ASPECT

You can switch the aspect ratio manually when needed.

### Aspect ratio options and projection example

If you apply the aspect ratio options to the projected image, the result will be as follows. The result may differ due to the input signals. See "Switching the aspect ratio" on page 23.

### VIDEO/S-VIDEO/COMPONENT

Not available with 1 125 (1 080)/50i, 1 125 (1 080)/60i, 1 125 (1 080)/50p, 1 125 (1 080)/60p, 1 125 (1 080)/24p, 750 (720)/50p and 750 (720)/60p signals.

Original size		4:3	Squeeze signal	16:9 Letter box	14:9 Letter Box	2.35:1 Cinescope
<b>4:3</b>	Projects at 4:3.					
<b>16:9</b>	Adjusts horizontally to 16:9.					
<b>JUST</b>	Adjusts horizontally to fit 16:9. Closer to edge, more enlarged. Not available with PC signals.					
<b>ZOOM/ZOOM1</b>	Adjusts to 16:9 size including letter box. Escape the menu mode and press ▲▼ to adjust vertically.					
<b>ZOOM2</b>	Adjusts to cinescope size not including letter box. Escape the menu mode and press ▲▼ to adjust vertically.					
<b>14:9</b>	Adjusts to 14:9.					

Settings

### COMPONENT signals

Available with 1 125 (1 080)/50i, 1 125 (1 080)/60i, 1 125 (1 080)/50p, 1 125 (1 080)/60p, 1 125 (1 080)/24p, 750 (720)/50p and 750 (720)/60p signals

Original Size		4:3	16:9	Cinescope
<b>H - FIT</b>	Adjusts horizontally to 16:9.			
<b>V - FIT</b>	Adjusts to 16:9 vertically. Escape and press ▲▼ to scroll the image to adjust the edge vertically.			

**V SCROLL:** Escape and press ▲▼ to scroll the image of PC signals to adjust the edge vertically.



## Aspect ratio depend on signals

Press ◀ ▶ to cycle through the aspect ratio options. The cycle pattern depends on the connected signals.

VIDEO/ S-VIDEO	<ul style="list-style-type: none"> <li>● 4:3 → 16:9 → 14:9 → JUST → ZOOM1 → ZOOM2</li> <li>● AUTO → 4:3 → 16:9 → JUST → ZOOM</li> </ul> NTSC signal
PC (RGB)	<ul style="list-style-type: none"> <li>● 4:3 → 16:9 → V SCROLL</li> <li>● 4:3 → 16:9</li> </ul> VGA or SVGA signals ● V SCROLL only WIDE768 ● Not switchable WIDE480/600/720/768-2 signals
HDMI	<ul style="list-style-type: none"> <li>● 4:3 → 16:9</li> <li>● 16:9 → H - FIT → V - FIT → ZOOM</li> </ul> 1 125 (1 080)/50i, 1 125 (1 080)/60i, 1 125 (1 080)/50p, 1 125 (1 080)/60p, 1 125 (1 080)/24p, 750 (720)/50p and 750 (720)/60p signals <ul style="list-style-type: none"> <li>● 4:3 → 16:9 → JUST → ZOOM</li> </ul> 525p (480p) and 625p (576p) signals
YPbPr	<ul style="list-style-type: none"> <li>● 4:3 → 16:9 → 14:9 → JUST → ZOOM1 → ZOOM2</li> </ul> 625i (576i), 625p (576p) <ul style="list-style-type: none"> <li>● AUTO → 4:3 → 16:9 → JUST → ZOOM</li> </ul> 525i (480i), 525p (480p) <ul style="list-style-type: none"> <li>● 16:9 → H - FIT → V - FIT</li> </ul> 1 125 (1 080)/50i, 1 125 (1 080)/60i, 1 125 (1 080)/50p, 1 125 (1 080)/60p, 1 125 (1 080)/24p, 750 (720)/50p, 750 (720)/60p signals

## WSS

If a PAL/625p (576p)/625i (576i) signal is input and that signal has an identification signal, the aspect ratio is automatically switched to the required setting. You can switch the system off manually.

## OVER SCAN





If the 4 edges of an image is partly dropped, you can use this function to adjust and project it properly.



- Setting range: 0 to +10
- OVER SCAN is not available with PC signals.

## KEYSTONE

If the projector is aligned non-perpendicularly to the screen, or if the projection screen has an angled surface, you can vertically correct keystone.

Image	Operation
	
	

- Setting range: -32 to 32

### NOTE:

- You can correct the distortion ± 30 degrees from the vertical plane. For a better quality image, installing the projector with a minimum of distortion is recommended.
- Some distortion may be retained for **Lens shift** adjustment.
- The distortion of the **Main menu** screen is not correctable.
- The result of the keystone correction will affect on the aspect ratio and the size of the image.

## AUTO SETUP

You can adjust **V - POSITION**, **H - POSITION**, **DOT CLOCK** and **CLOCK PHASE** automatically when connecting via **PC**. Press **ENTER** to adjust these at the same time.

# OPTION Menu

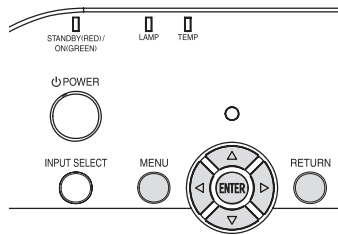
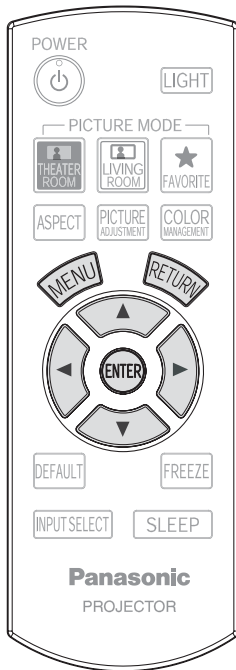

See “Navigating through the MENU” on page 26.

## OSD POSITION

You can change the position where to display the menu. Press ◀ ▶ to cycle through the options.

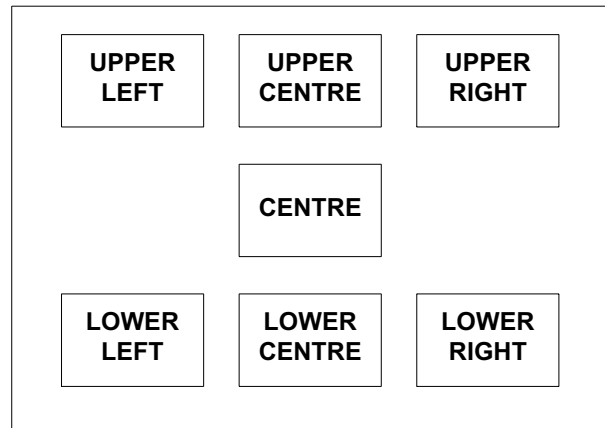

## BACK COLOR

You can choose a **BLUE** or **BLACK** screen for when the projector is idle. Press ◀ ▶ to select an option.

## STARTUP LOGO

You can switch on/off the logo that is displayed when starting up. Press ◀ ▶ to select an option.

- **ON:** Active
- **OFF:** Deactive

## AUTO SEARCH

When the projector is turned on, the input terminals are detected and an input signal is selected automatically. You can switch on/off the system. Press ◀ ▶ to select an option.

- **ON:** Active
- **OFF:** Deactive

### NOTE:

- When no signal is detected, the last used input method will be selected.

## HDMI SIGNAL LEVEL

You can switch the **HDMI** signal level **NORMAL** or **EXPAND** when an **HDMI** (RGB) signal selected. Press ◀ ▶ to select an option.

## INPUT GUIDE

When you press **INPUT** or the **INPUT SELECT** button to change the input method, the guidance is indicated in the upper right corner of the screen. The following display methods are available. Press ◀ ▶ to cycle through the options.

Options	Function
<b>OFF</b>	Turn off the guidance.
<b>SIMPLE</b>	Display the input method by text. The <b>INPUT GUIDE</b> will go out after 5 seconds without any operation.
<b>DETAILED</b>	Display the input method by graphic. The <b>INPUT GUIDE</b> will go out after 10 seconds without any operation.

## OSD DESIGN

You can change the background color of the menu. Press ◀ ▶ to cycle through the options.

Options	Function
<b>TYPE1</b>	Semi transparent black
<b>TYPE2</b>	Solid blue
<b>TYPE3</b>	Semi transparent dark blue

## INSTALLATION

When installing the projector, select the projection method according to the projector position. Press ◀ ▶ to cycle through the options. See “Projection method” on page 15.

<b>FRONT/DESK</b>	Setting on a desk/floor and projecting from front
<b>FRONT/CEILING</b>	Mounting in the ceiling and projecting from front
<b>REAR/DESK</b>	Setting on a desk/floor and projecting from rear
<b>REAR/CEILING</b>	Mounting in the ceiling and projecting from rear

## SLEEP

You can select the required duration of time and set the off timer to turn off the **POWER** of the projector automatically. 3 minutes before turn-off, the countdown of minutes will be displayed in the lower right corner. Press ◀ ▶ to cycle through the options. See “Switching off the projector automatically” on page 23.

## ALTITUDE

If you use the projector at high elevations, set the fan speed to **HIGH**. Press ◀ ▶ to select **HIGH** or **LOW**.

### NOTE:

- At 1 400 m (4593 ft) above sea level, the setting must be **HIGH**.

## LAMP POWER

You can adjust the power of the lamp to save on electricity, prolong the lamp life and reduce the noise.

Options	Function
<b>NORMAL</b>	When higher luminance is required such as movies
<b>ECO - MODE</b>	When lower luminance is sufficient such as in a small room

### NOTE:

- When no input signal is detected, the function is disabled.

## LAMP RUNTIME

You can check how long time has been the lamp used.

### NOTE:

- **LAMP RUNTIME** is a relevant matter for lamp replacement timing. See “Care and Replacement” on page 37.

## TEST PATTERN

You can use the 2 different of test pattern to adjust the focus of the image. The **PICTURE MODE** is switched to **DYNAMIC** temporarily, and return to the last used setting when return to projection.

1. Press **ENTER** to display test pattern 1 and adjust the focus with the **Focus ring**.

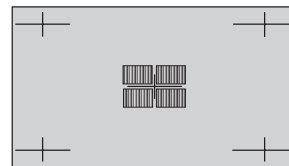

2. Press **ENTER** to display test pattern 2 and adjust the focus with the **Focus ring** again.

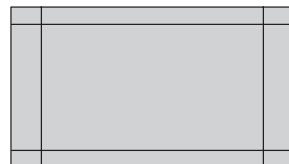

3. Press **MENU** or **RETURN** to return to the previous menu, or press repeatedly to return to the screen.

### NOTE:

- While a test pattern is displayed, the **PICTURE MODE** is changed temporarily to **DYNAMIC**.
- When the projector and/or the screen is tilted, adjust the focus at the center of the image. The upper and lower edge might be out of focus.
- When the image is distorted in keystone, adjust the **KEystone** in **POSITION** menu.

# TEMP and LAMP Indicators

## Controlling alerts

If a problem should occur with the projector, the **TEMP** and/or **LAMP** indicators will alert you. Respond to the alert as follows.

1. Confirm the **POWER** indicator status and turn off the projector in the proper way.
2. Find out the cause of the problem.
3. Follow the instructions for each indication below and solve the problem.
4. Turn on the projector in the correct way and confirm the indicator is not indicating a problem any longer.

### NOTE:

- If no problem is found or the problem remains, do not turn on the projector. Instead contact an Authorized Service Center.

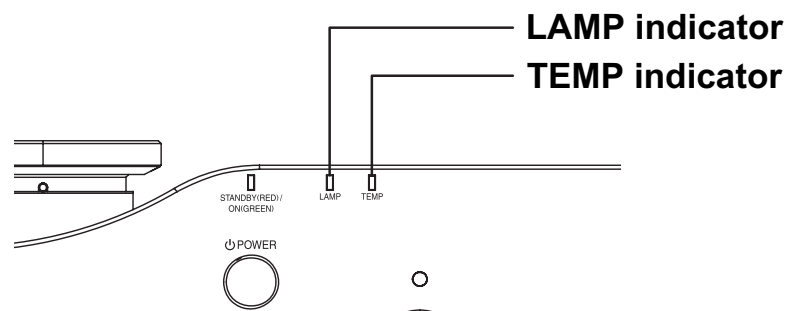

## TEMP indicator

<b>Indicator and projector</b>	<ul style="list-style-type: none"> <li>● Illuminating <b>RED</b> and still projecting</li> <li>● Flashing <b>RED</b> and <b>POWER</b> is turned off</li> </ul>		
<b>Problem</b>	The temperature inside and/or outside the projector is abnormally high.		
<b>Cause</b>	The ventilation ports are covered.	The room temperature is too high.	The <b>Air filter</b> is excessively dirty and the ventilation is poor.
<b>Remedy</b>	Remove the object(s) from the ventilation ports or clear around the projector.	Reinstall the projector at a temperature controlled place. See "Setting up" on page 14.	Clean or replace the <b>Air filter</b> in the proper way. See "Cleaning the Air filter" on page 37.

## LAMP indicator

<b>Indicator</b>	● Illuminating <b>RED</b>	● Flashing <b>RED</b>
<b>Problem</b>	<b>LAMP RUNTIME</b> has reached 1 800 hours (with <b>LAMP POWER</b> set to <b>NORMAL</b> ).	<b>LAMP</b> circuit failure or abnormal function.
<b>Cause</b>	<b>Lamp unit</b> will run out soon and needs to be replaced.	The projector is switched off incorrectly.
<b>Remedy</b>	Replace the <b>Lamp unit</b> . See "Before replacing the Lamp unit" on page 38.	<ul style="list-style-type: none"> <li>● Let the <b>LAMP</b> cool down and turn on the projector.</li> <li>● If the <b>POWER</b> does not turn on, contact an Authorized Service Center.</li> </ul>

# Care and Replacement

## Before cleaning

- Ensure the projector is switched off.
- Unplug all the cables from the projector.

## Cleaning your projector

### Cleaning the outer surface of the projector

Wipe off dirt and dust gently with a soft cloth.

- If it is difficult to remove the dirt, soak a cloth in a neutral detergent diluted with water, wring the cloth well and then wipe the projector. Dry off the projector with dry cloth.
- If you use a chemical treated wipe, follow the instructions supplied with it.

### Cleaning the lens surface

Wipe off dirt and dust gently with a lint-free cloth.

- Make sure no dirt or dust remains on the surface of the lens. It will be enlarged and projected onto a screen.

### Cleaning the Air filter

If the **Air filter** is excessively dirty, the internal temperature of the projector increases and may cause malfunction. Clean the **Air filter** regularly every 100 hours of usage.

1. Turn the projector upside down and place it gently on a soft cloth.
2. Press the tab and slightly slide up the **Air filter** to remove.

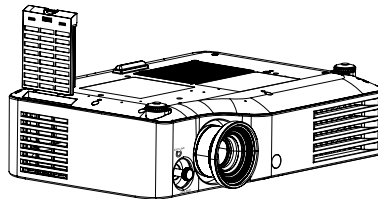

3. Vacuum dirt and dust from the **Air filter**.
  - Do not wash the **Air filter**.

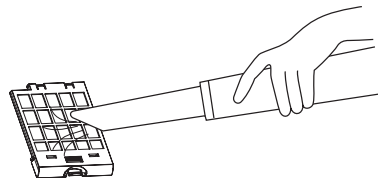

4. Place and slightly slide in the **Air filter** in the **Air intake port** to attach.
  - Make sure the **Air filter** clicks into the place.

#### NOTE:

- Do not use the projector without attaching the **Air filter**.

### Replacing the Air filter

The **Air filter** should be replaced when cleaning is ineffective and when replacing the **Lamp unit**. An replacement **Air filter** is provided with a replacement lamp unit, ET - LAX100. Contact an Authorized Service Center for the optional **Air filter**.

# Care and Replacement

## Before replacing the Lamp unit



- Ensure the projector is switched off.
- Unplug all the cables from the projector.
- Prepare a Phillips-head screwdriver.
- Contact an Authorized Service Center to purchase a replacement **Lamp unit** (ET-LAX100).

**NOTE:**

- Prior to replacing the lamp unit, allow it to cool down to prevent the risk of burns, damage and other hazards.
- Do not attempt replacement with an unauthorized lamp unit.

## When to replace the Lamp unit

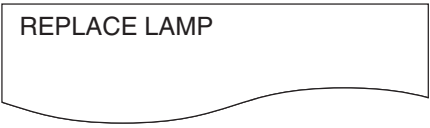
The **Lamp unit** is consumable and the brightness decreases by duration of usage. The **LAMP** indicator will alert you of the replacement timing at 1 800 hours, and at 2 000 hours, the projector will be turned off. 1 800 or 2 000 hours is a rough guidance and might be shortened by the usage conditions, characteristics of the lamp unit, environmental conditions, and so on. You can check the duration of usage time using **LAMP RUNTIME** in the **OPTION** menu.

Indication	On screen 	<b>LAMP</b> indicator 
<b>Over 1 800 hours</b>	<b>"REPLACE LAMP"</b> is displayed on the upper left of the screen for 30 seconds. To clear the screen immediately, press any button.	Illuminates <b>RED</b>
<b>Over 2 000 hours</b>	<b>"REPLACE LAMP"</b> is displayed on the upper left of the screen, and until you respond it will stay. To clear the screen, press any button.	

**NOTE:**

- The guide times, 1 800 and 2 000 hours, are rough estimates based on certain conditions and is not a guaranteed time. The estimated condition is: **LAMP POWER** in **OPTION** menu set to **NORMAL**.
- To prolong the lamp life, set the **LAMP POWER** in **OPTION** menu to **ECO - MODE**. See "LAMP POWER" on page 35.
- For more information about the **Lamp unit**, such as guaranteed time, see the "Replacement Instructions" provided with the **Lamp unit**.

## Replacing the lamp unit

### Replacing

1. Turn off the **MAIN POWER** switch according to the procedure "Switching the projector on/off" on page 19, and then disconnect the power cord plug from the wall outlet and check that the area around the lamp unit has cooled down.
2. Use a Phillips screwdriver to turn the lamp unit cover fixing screws at the bottom of the projector, and then remove the lamp unit cover.
3. Use a Phillips screw driver to loosen the two lamp unit fixing screws until the screws turn freely. Then hold the handle of the lamp unit and gently pull it out from the projector.
4. Insert the new lamp unit while making sure that the direction of insertion is correct, and then use a Phillips screwdriver to securely tighten the lamp unit fixing screw.
5. Install the lamp unit cover, and then use a Phillips screwdriver to securely tighten the lamp unit cover fixing screws.

Lamp unit cover fixing screws

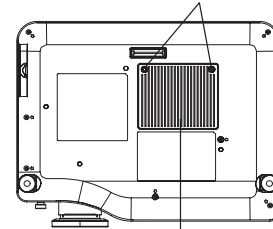

Lamp unit cover

Lamp unit fixing screws

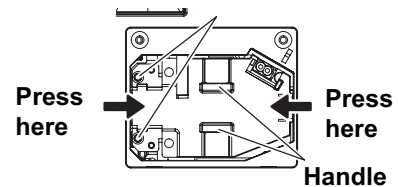

Handle

#### NOTE:

- Be sure to install the lamp unit and the lamp unit cover securely. If they are not securely installed, it may cause the protection circuit to operate so that the power cannot be turned on.
- Grip the handle when you remove the lamp unit. Some parts of the lamp unit are sharpened and may cause injury.

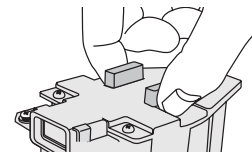

### Resetting the LAMP RUNTIME

If the lamp usage time has passed 2 000 hours (when **LAMP POWER** has been set to **NORMAL**), the projector will switch to standby mode after approximately 10 minutes of operation. The resetting procedure should thus be completed within 10 minutes.

1. Insert the power cord plug into the wall outlet and then press the **MAIN POWER** switch.
2. Press the **POWER** button so that a picture is projected onto the screen.
3. Press the **MENU** button to display the menu screen, and then press the **▲** or **▼** button to select the **OPTION** menu.
4. Press the **ENTER** button, and then press the **▲** or **▼** button to select **LAMP RUNTIME**.
5. Press and hold the **ENTER** button for approximately 3 seconds. The confirmation screen, "**LAMP RUNTIME RESET.**" is displayed and select **OK**.
6. Turn off the power.
  - This will reset the cumulative usage time for the lamp unit to zero.

INPUT GUIDE	DETAILED
OSD DESIGN	TYPE1
OSD POSITION	CENTRE
BACK COLOUR	BLUE
STARTUP LOGO	ON
AUTO SEARCH	ON
HDMI SIGNAL LEVEL	NORMAL
INSTALLATION	FRONT/DESK
SLEEP	OFF
ALTITUDE	LOW
LAMP POWER	NORMAL
LAMP RUNTIME	1820H
TEST PATTERN	

# Troubleshooting

Should any problem persist, contact your dealer.

Problem	Cause	Reference page
<b>Power does not turn on.</b>	● The power cord may not be connected.	19
	● The <b>MAIN POWER</b> switch is turned off.	20
	● No electric supply is at the wall outlet.	19
	● <b>TEMP</b> indicator is lit or flashes.	36
	● <b>LAMP</b> indicator is lit or flashes.	36
	● The lamp unit cover has not been securely installed.	39
<b>No picture appears.</b>	● The video signal input source may not be connected to a terminal properly.	18
	● The input selection setting may not be correct.	22
	● The <b>BRIGHTNESS</b> adjustment setting may be at the minimum setting.	28
	● The <b>SHUTTER</b> function may be in use.	42
<b>The picture is fuzzy.</b>	● The lens cover may still be attached to the lens.	12
	● The lens focus may not have been set correctly.	21
	● The projector may not be at the correct distance from the screen.	14
	● The lens may be dirty.	37
	● The projector may be tilted too much.	14
<b>The color is pale or greyish.</b>	● <b>COLOR</b> or <b>TINT</b> adjustment may be incorrect.	28
	● The input source which is connected to the projector may not be adjusted correctly.	18
<b>The Remote control does not operate.</b>	● The batteries may be weak.	11 22
	● The batteries may not have been inserted correctly.	
	● The remote control signal receptor on the projector may be obstructed.	
	● The remote control unit may be out of the operation range.	
<b>The picture does not display correctly.</b>	● The signal format ( <b>TV-SYSTEM</b> ) may not have been set correctly.	30
	● There may be a problem with the VCR or other signal source.	-
	● A signal which is not compatible with the projector is being input.	43
<b>Picture from a computer does not appear.</b>	● The cable may be too long.	-
	● The external video output from a laptop computer may not be correct. (You may be able to change the external output settings by pressing the [Fn] + [F3] or [Fn] + [F10] keys simultaneously. The actual method varies depending on the type of computer; refer to the documentation provided with your computer for further details.)	-



# Technical Information

## List of compatible signals

Mode	Display resolution (dots) <sup>1</sup>	Scanning frequency		Dot clock frequency (MHz)	Picture quality <sup>2</sup>	Format
		H (kHz)	V (kHz)			
NTSC/NTSC 4.43/ PAL-M/PAL60	720 x 480i	15.7	59.9		A	VIDEO/S-VIDEO
PAL/PAL-N/SECAM	720 x 576i	15.6	50.0		A	VIDEO/S-VIDEO
525i (480i)	720 x 480i	15.7	59.9	13.5	A	COMPONENT
625i (576i)	720 x 576i	15.6	50.0	13.5	A	COMPONENT
525p (480p)	720 x 483	31.5	59.9	27.0	A	COMPONENT/HDMI
625p (576p)	720 x 576	31.3	50.0	27.0	A	COMPONENT/HDMI
1 125 (1 080)/60i	1 920 x 1 080i	33.8	60.0	74.3	AA	COMPONENT/PC/ HDMI
1 125 (1 080)/50i	1 920 x 1 080i	28.1	50.0	74.3	AA	COMPONENT/PC/ HDMI
1 125 (1 080)/24p	1 920 x 1 080	27.0	24.0	74.3	AA	COMPONENT/HDMI
1 125 (1 080)/60p	1 920 x 1 080p	67.5	60.0	148.5	AA	COMPONENT/PC/ HDMI
1 125 (1 080)/50p	1 920 x 1 080p	56.3	50.0	148.5	AA	COMPONENT/PC/ HDMI
750 (720)/60p	1 280 x 720	45.0	60.0	74.3	AA	COMPONENT/HDMI
750 (720)/50p	1 280 x 720	45.0	50.0	74.3	AA	COMPONENT/HDMI
VGA480	640 x 480	31.5	59.9	25.2	A	PC/HDMI
	640 x 480	37.5	75.0	31.5	A	PC
	640 x 480	43.3	85.0	36.0	A	PC
	640 x 480	72.1	138.0	62.3	A	PC
WIDE480	856 x 480	30.1	60.1	31.5	A	PC
SVGA	800 x 600	35.2	56.3	36.0	A	PC
	800 x 600	37.9	60.3	40.0	A	PC
	800 x 600	48.1	72.2	50.0	A	PC
	800 x 600	46.9	75.0	49.5	A	PC
	800 x 600	53.7	85.1	56.3	A	PC
WIDE600	1 072 x 600	37.2	59.9	51.4	A	PC
WIDE720	1 280 x 720	45.1	60.1	76.5	AA	PC
XGA	1 024 x 768	48.4	60.0	65.0	A	PC
	1 024 x 768	58.5	70.1	75.0	A	PC
	1 024 x 768	60.0	75.0	78.8	A	PC
	1 024 x 768	68.7	85.0	94.5	A	PC
	1 024 x 768	72.1	89.0	99.2	A	PC
WIDE768	1 280 x 768	45.3	56.5	76.2	A	PC
MXGA	1 152 x 864	64.0	71.2	94.2	A	PC
	1 152 x 864	67.5	74.9	108.0	A	PC
SXGA	1 280 x 1024	64.0	60.0	108.0	A	PC
WIDE768-2	1 366 x 768	48.8	59.8	73.8	A	PC

- The "i" appearing after the resolution indicates an interlaced signal.
- The following symbols are used to indicate picture quality.
  - AA Maximum picture quality can be obtained.
  - A Signals are converted by the image processing circuit before picture is projected.

# Technical Information

## Serial terminal

The serial connector which is on the connector panel of the projector conforms to the RS-232C interface specification, so that the projector can be controlled by a personal computer which is connected to this connector.

### Connection

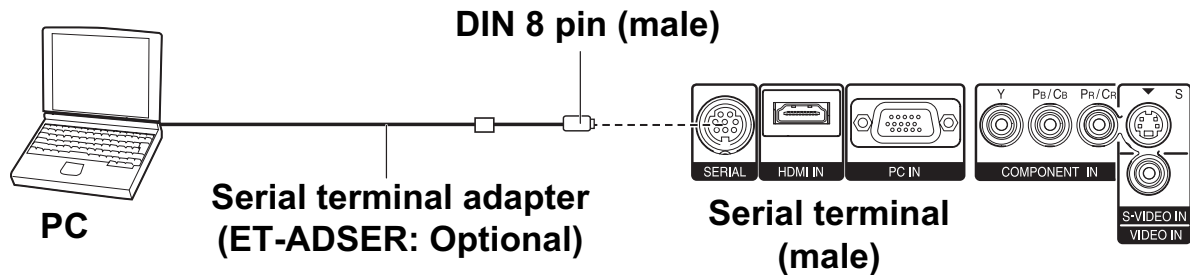

#### NOTE:

- You must use only an RS-232C Serial Interface Cable with a ferrite core, type ET-ADSER.

### Pin assignments and signal names

	Pin No.	Signal name	Contents
	③	RXD	Received data
	④	GND	Earth
	⑤	TXD	Transmitted data
	①		Connected internally
	②		
	⑥		
	⑦		NC
	⑧		NC

### Communication settings

Signal level	RS-232C	Character length	8 bits
Sync. method	Asynchronous	Stop bit	1 bit
Baud rate	9 600 bps	X parameter	None
Parity	None	S parameter	None



# Technical Information

## Inquiry commands

Command	Control contents	Parameter	
<b>QPW</b>	Power condition	000 = OFF	001 = ON
<b>QIN</b>	Input signal	VID = VIDEO IN RG1 = PC IN	SVD = S-VIDEO IN YUV = COMPONENT IN HDM = HDMI IN
<b>QPM</b>	Picture mode	Parameter: NAT=NATURAL DYN=DYNAMIC CN2=CINEMA2 VID=VIDEO (See page 33)	NOR=NORMAL CN1=CINEMA1 CN3=VIVID CINEMA
<b>QSH</b>	Shutter function	0 = OFF	1 = ON
<b>QFZ</b>	Freeze function	0 = OFF	1 = ON
<b>QOT</b>	SLEEP function	0 = OFF    1 = 60 min.    2 = 90 min.    3 = 120 min.    4 = 150 min. 5 = 180 min.    6 = 210 min.    7 = 240 min. (page 23)	

## Cable specifications

(When connected to a personal computer)

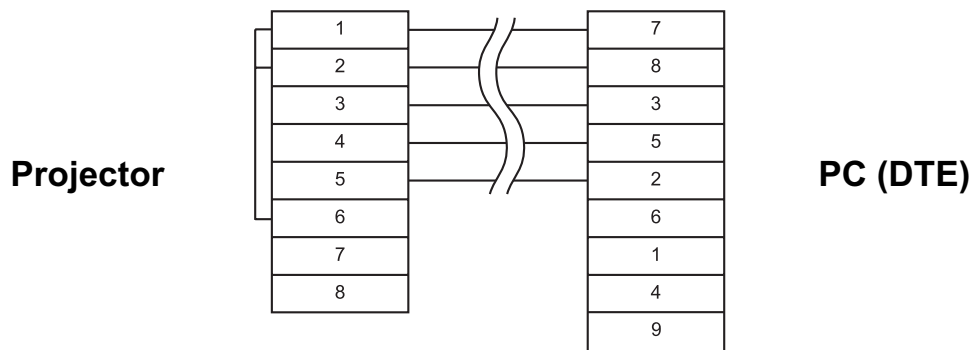

Menu structure

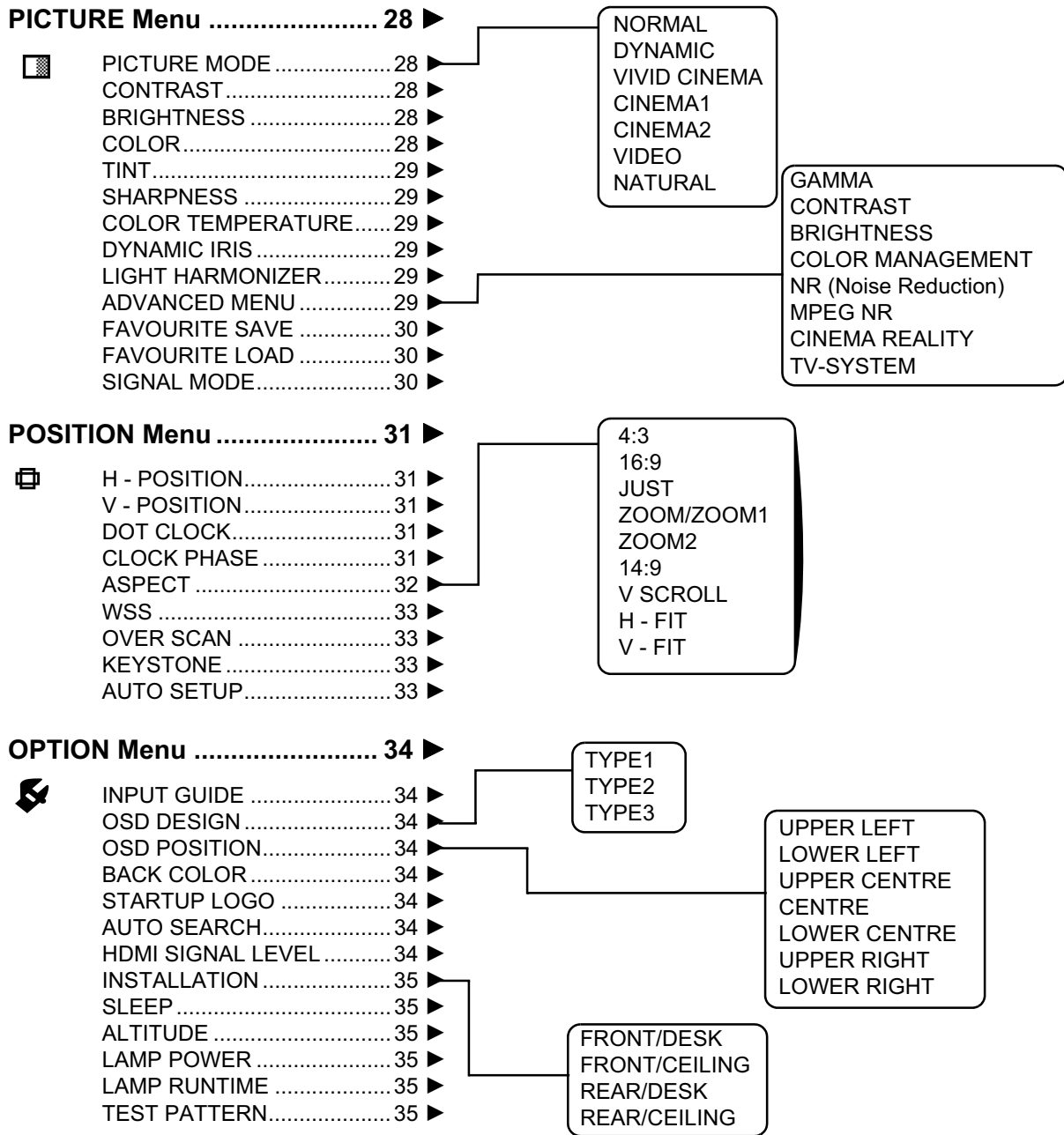

● Sub-menu items vary according to the selected input signal.

# Specifications

<b>Power supply</b>		AC 100 - 240 V 50 Hz/60 Hz
<b>Power consumption</b>		290 W During standby (when fan is stopped): 0.08 W
<b>Amps</b>		3.5 A - 1.5 A
<b>LCD panel</b>	<b>Panel size (diagonal)</b>	0.7 type (17.78 mm)
	<b>Aspect ratio</b>	16 : 9
	<b>Display method</b>	3 transparent LCD panels (RGB)
	<b>Drive method</b>	Active matrix method
	<b>Pixels</b>	921 600 (1 280 x 720) x 3 panels
<b>Lens</b>		Manual zoom (2 x)/Manual focus F 1.9 - 3.1, f 21.7 mm - 43.1 mm
<b>Lamp</b>		UHM lamp (220 W)
<b>Luminosity</b>		2 000 lm
<b>Scanning frequency (for RGB signal)</b>	<b>Horizontal scanning frequency</b>	30 kHz - 70 kHz
	<b>Vertical scanning frequency</b>	50 Hz - 87 Hz
	<b>Dot clock frequency</b>	Less than 150 MHz
<b>COMPONENT (YPBPR) signals</b>		525i (480i), 525p (480p), 625i (576i), 625p (576p), 1 125 (1 080)/24p, 750 (720)/50p, 750 (720)/60p, 1 125 (1 080)/50i, 1 125 (1 080)/60i, 1 125 (1 080)/50p, 1 125 (1 080)/60p
<b>Color system</b>		7 (NTSC/NTSC 4.43/PAL/PAL-M/PAL-N/SECAM)
<b>Projection size</b>		1 016 mm - 5 080 mm (40" - 200")
<b>Throw distance</b>		1.2 m - 12.4 m (3'11" - 40'8")
<b>Screen aspect ratio</b>		16 : 9
<b>Installation</b>		Front/Rear/Ceiling/Desk (Menu selection method)

## Specifications

<b>Connectors</b>	<b>S-VIDEO IN</b>	Single - line, Mini DIN 4p Y: 1.0 V [p-p], C: 0.286 V [p-p], 75 Ω	
	<b>VIDEO IN</b>	Single - line, RCA pin jack 1.0 V [p-p], 75Ω	
	<b>PC IN</b>	RGB	Single - line, D - sub HD 15-pin (female)
		● R.G.B.	0.7 V [p-p], 75 Ω
		● G.SYNC	1.0 V [p-p], 75 Ω
		● HD/SYNC	TTL high impedance, automatic positive/negative polarity compatible
● VD	TTL high impedance, automatic positive/negative polarity compatible		
<b>COMPONENT IN</b>	Y, PB/CB, PR/CR	Single - line, RCA pin jack x 3	
	● Y:	1.0 V [p-p] (including sync), 75 Ω	
	● PB/CB, (PR/CR)	0.7 V [p-p], 75 Ω	
	<b>HDMI IN</b>	Single - line, 19-pin HDMI connector	
	<b>SERIAL</b>	DIN 8-pin RS-232C compatible	
<b>Cabinet</b>	Moulded plastic (ABS/PC)		
<b>Dimensions</b>	● Width	395 mm (15 - 17/32")	
	● Height	112 mm (4 - 13/32")	
	● Length	300 mm (11 - 25/32")	
<b>Weight</b>	4.9 kg (10.8 lbs.)		
<b>Operating environment</b>	● Temperature	0 °C - 40 °C (32 °F - 104 °F) When the <b>ALTITUDE</b> (page 35) is set to <b>HIGH</b> : 0 °C - 35 °C (32 °F - 95 °F)	
	● Humidity	20% - 80% (no condensation)	
<b>Certifications</b>	UL60950-1 FCC Class B	C-UL ICES-003	
<b>Remote control</b>	<b>Power supply</b>	3 V DC (AA battery x 2)	
	<b>Operating range</b>	Approx. 7 m (23') (when operated directly in front of signal receptor)	
	<b>Weight</b>	125 g (4.4 ozs.) (including batteries)	
	<b>Dimensions</b>	● Width	48 mm (1 - 7/8")
● Length		138 mm (5 - 13/32")	
● Height		28.35 mm (1-3/32") (not including projecting parts)	
<b>Options</b>	<b>Ceiling bracket</b>	ET-PKX100	
	<b>Projection screen</b>	ET-SRW90CT	
	<b>Serial adapter</b>	ET-ADSER (DIN 8-pin/D-sub 9-pin)	

# Dimensions

Units: mm (inch)

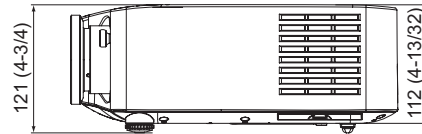
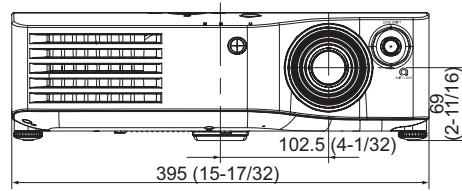
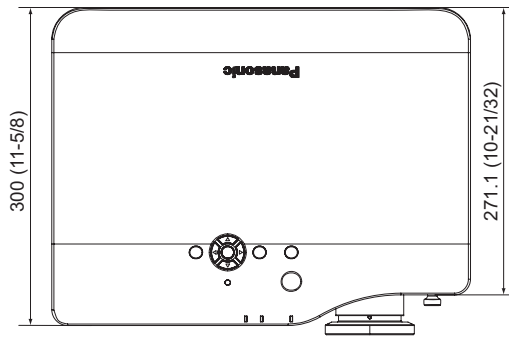



# Trademark acknowledgements

- VGA and XGA are trademarks of International Business Machines Corporation.
- S-VGA is a registered trademark of the Video Electronics Standards Association.
- HDMI, the HDMI logo and High-Definition Multimedia Interface are trademarks or registered trademarks of HDMI Licensing LLC.
- The font used in the on-screen displays is a Ricoh bitmap font, which is manufactured and sold by Ricoh Company, Ltd.

All other trademarks are the property of the various trademark owners.

## Information on Disposal in other Countries outside the European Union



This symbol is only valid in the European Union.

If you wish to discard this product, please contact your local authorities or dealer and ask for the correct method of disposal.



# Index

<b>A</b>		<b>F</b>	
AC IN.....	13	FAVOURITE	
Accessories.....	9	FAVOURITE LOAD.....	30
ADVANCED MENU.....	29	Opening the menu.....	23
Air exhaust port.....	12	Remote control button.....	11
Air filter.....	37	FAVOURITE SAVE.....	30
Air intake port.....	12, 13	Focus ring.....	12
ALTITUDE.....	35	Image positioning.....	21
ASPECT.....	32	FREEZE	
Options.....	32	Capturing.....	22
Remote control button.....	11	Remote control button.....	11
Signals.....	33	Front leg adjuster.....	13
Switching.....	23	Adjusting.....	15
AUTO SEARCH.....	34	Image positioning.....	21
AUTO SETUP.....	33	<b>G</b>	
<b>B</b>		GAMMA.....	29
BACK COLOR.....	34	<b>H</b>	
Battery		H- POSITION.....	31
Accessory.....	9	HDMI	
Compartment.....	11	Connecting.....	18
BRIGHTNESS.....	28, 29	SIGNAL LEVEL.....	34
<b>C</b>		Terminal.....	13
CINEMA REALITY.....	30	<b>I</b>	
Cleaning.....	37	INPUT	
CLOCK PHASE.....	31	Button on the projector.....	12
COLOR.....	28	INPUT GUIDE.....	34
COLOR MANAGEMENT.....	29	Remote control button.....	11
Adjusting.....	24	Selecting signal.....	21, 22
Opening the menu.....	24	INSTALLATION.....	35
Remote control button.....	11	Projection method.....	15
COLOR TEMPERATURE.....	29	<b>K</b>	
COMPONENT IN		KEYSTONE.....	33
Connecting.....	18	<b>L</b>	
Terminal.....	13	LAMP	
CONTRAST.....	28, 29	Indicator.....	12
<b>D</b>		Indicator status.....	36, 38
DEFAULT		LAMP POWER.....	35
Remote control button.....	11	LAMP RUNTIME.....	35
Resetting.....	23	Lamp unit component.....	13
DOT CLOCK.....	31	Replacing.....	38
DYNAMIC IRIS.....	29	LANGUAGE.....	27
<b>E</b>		Lens cover.....	12
ENTER		LIGHT	
Button.....	12	On/Off.....	23
Remote control button.....	11	Remote control button.....	11
		LIGHT HARMONIZER.....	29
		LIVING ROOM	
		Remote control button.....	11
		Switching.....	23
		LOG	
		Managing.....	25
		Setting as a profile.....	25
		LUMINANCE SENSOR.....	12

<b>M</b>		<b>S</b>	
MAIN POWER		Screen size .....	14
On/Off .....	19	Security lock .....	13
Switch .....	13	SERIAL	
MENU		Connecting.....	42
Button on the projector.....	12	Terminal .....	13
Main menu .....	26	SHARPNESS.....	29
Opening the menu .....	26	Shift lens	
Remote control button.....	11	Image positioning .....	21
MPEG NR .....	30	Positioning .....	16
<b>N</b>		Shift lever .....	12
NR (Noise Reduction) .....	30	SIGNAL MODE .....	30
<b>O</b>		SLEEP .....	35
OPTION		Remote control button .....	11
Operation .....	34	Setting .....	23
Sub-menu .....	27	STARTUP LOGO .....	34
OSD DESIGN.....	34	S-VIDEO IN	
OSD POSITION.....	34	Connecting.....	18
OVER SCAN .....	33	Terminal .....	13
<b>P</b>		<b>T</b>	
PC IN		TEMP	
Connecting .....	18	Indicator .....	12
Terminal .....	13	Indicator status .....	36
PICTURE		TEST PATTERN .....	35
Operation .....	28	THEATER ROOM	
Sub-menu .....	27	Remote control button .....	11
PICTURE ADJUSTMENT		Switching .....	23
Opening the menu .....	24	Throw distance.....	14
Remote control button.....	11	Throwing angle.....	15
PICTURE MODE .....	28	TINT .....	29
Switching .....	23	TV-SYSTEM .....	30
POSITION		<b>V</b>	
Operation .....	31	V- POSITION .....	31
Sub-menu .....	27	VIDEO IN	
POWER		Connecting.....	18
Indicator.....	12	Terminal .....	13
Indicator status.....	19	<b>W</b>	
On/Off .....	20	WSS.....	33
Power cord		<b>Z</b>	
Accessory .....	9	Zoom ring .....	12
Connection .....	19	Image positioning .....	21
PROFILE			
Create new .....	24		
Loading .....	25		
Projection lens .....	12		
<b>R</b>			
Remote control .....	11		
Operating range .....	22		
Operation .....	22		
Signal emitter.....	11		
Signal receptor.....	12		
RETURN			
Button .....	12		
Remote control button.....	11		

